

# Rider's Manual

## R 1200 GS Adventure



BMW Motorrad



The Ultimate  
Riding Machine

## Motorcycle data/dealership details

### Motorcycle data

---

Model

---

Vehicle identification number

---

Colour code

---

Date of first registration

---

Registration number

### Dealership details

---

Person to contact in Service department

---

Ms/Mr

---

Phone number

---

Dealership address/phone number (company stamp)

## Welcome to BMW

We congratulate you on your choice of a motorcycle from BMW and welcome you to the community of BMW riders.

Familiarise yourself with your new motorcycle so that you can ride it safely and confidently in all traffic situations.

Please read this Rider's Manual carefully before starting to use your new BMW motorcycle. It contains important information on how to operate the controls and how to make the best possible use of all your BMW's technical features.

In addition, it contains information on maintenance and care to help you maintain your motorcycle's reliability and safety, as well as its value.

If you have questions concerning your motorcycle, your authorised

BMW Motorrad dealer will gladly provide advice and assistance.

We hope that you will enjoy riding your BMW and that all your journeys will be pleasant and safe.

BMW Motorrad.

# Table of Contents

You can also consult the index at the end of this Rider's Manual if you want to find a particular topic or item of information.

1 General instructions	5	3 Status indicators	21	Tyre pressure monitoring	
Overview	6	Standard status indicators	22	RDC	54
Abbreviations and symbols	6	Status indicators with on-board computer	23	Lights	55
Equipment	7	Status indicators with tyre pressure monitoring (RDC)	24	Turn indicators	56
Technical data	7	Standard warnings	24	Hazard warning flashers	56
Currency	7	Warnings issued by the on-board computer	29	Emergency off switch (kill switch)	57
2 General views	9	ABS warnings	31	Operating grip heating	58
General view, left side	11	ASC warnings	33	BMW Motorrad Integral ABS	59
General view, right side	13	RDC warnings	36	Automatic Stability Control ASC	60
Handlebar fitting, left	14	Anti-theft alarm warnings	41	Seat height	61
Handlebar fitting, right	16	4 Operation	45	Windscreen	62
Underneath the seat	17	Ignition switch and steering lock	46	Clutch	62
Instrument panel	18	Electronic immobiliser EWS	47	Brakes	63
Headlight	19	Clock	48	Shift mechanism	64
		Odometer and tripmeters	49	Mirrors	64
		On-board computer	51	Handlebars	65
				Spring preload	65
				Damping	67
				Electronic Suspension Adjustment ESA	68
				Tyres	71

Headlight.....	71	7 Accessories.....	97	Laying up motorcycle.....	142
Front and rear seats.....	72	General instructions.....	98	Restoring motorcycle to use.....	142
Helmet holder.....	73	Power sockets.....	98	10 Technical data.....	143
5 Riding.....	75	Case.....	99	Troubleshooting chart.....	144
Safety instructions.....	76	Topcase.....	101	Threaded fasteners.....	145
Checklist.....	78	8 Maintenance.....	105	Engine.....	147
Starting.....	78	General instructions.....	106	Fuel.....	148
Running in.....	81	Toolkit.....	106	Engine oil.....	149
Off-roading.....	82	Engine oil.....	107	Clutch.....	150
Brakes.....	83	Brake system.....	108	Transmission.....	150
Parking your motorcycle.....	84	Clutch.....	114	Rear-wheel drive.....	151
Refuelling.....	85	Rims and tyres.....	114	Running gear.....	151
Secure the motorcycle for transportation.....	86	Wheels.....	115	Brakes.....	152
6 Engineering details.....	89	Front-wheel stand.....	121	Wheels and tyres.....	153
Brake system with BMW Motorrad Integral ABS.....	90	Bulbs.....	123	Electrics.....	154
Electronic engine manage- ment with BMW Motorrad ASC.....	92	Air filter.....	130	Frame.....	156
Tyre pressure monitoring RDC.....	94	Jump starting.....	133	Dimensions.....	156
Electronic Suspension Ad- justment ESA.....	95	Battery.....	134	Weights.....	157
		9 Care.....	139	Riding specifications.....	157
		Care products.....	140		
		Washing motorcycle.....	140		
		Cleaning easily damaged components.....	140		
		Paint care.....	141		
		Protective wax coating.....	142		

11 Service .....	159
BMW Motorrad service....	160
BMW Motorrad service quality .....	160
BMW Motorrad mobility services - roadside assist- ance.....	160
BMW Motorrad service network .....	161
Maintenance work.....	161
Confirmation of mainten- ance work .....	162
Confirmation of service....	167

## General instructions

Overview .....	6
Abbreviations and symbols .....	6
Equipment .....	7
Technical data .....	7
Currency .....	7

## Overview

Chapter 2 of this Rider's Manual will provide you with an initial overview of your motorcycle. All maintenance and repair work on the motorcycle is documented in Chapter 11. This record of the maintenance work you have had performed on your motorcycle is a precondition for generous treatment of goodwill claims.

When the time comes to sell your BMW, please remember to hand over this Rider's Manual; it is an important part of the motorcycle.

## Abbreviations and symbols



Indicates warnings that you must comply with for reasons of your safety and the safety of others, and to protect your motorcycle against damage.



Specific instructions on how to operate, control, adjust or look after items of equipment on the motorcycle.



Indicates the end of an item of information.



Instruction.



Result of an activity.



Reference to a page with more detailed information.



Indicates the end of a passage relating to specific accessories or items of equipment.



Tightening torque.



Item of technical data.

OE

Optional extra  
The motorcycles are assembled complete with all the BMW optional extras originally ordered.

OA

Optional accessory  
You can obtain optional accessories through your authorised BMW Motorrad dealer; optional accessories have to be retrofitted to the motorcycle.

EWS

Electronic immobiliser.

DWA

Anti-theft alarm (Diebstahlwarnanlage)

ABS

Anti-lock brake system

ASC

Automatic Stability Control.



ESA Electronic Suspension Adjustment  
Electronic Suspension Adjustment.

RDC Tyre pressure control  
(ReifenDruck-Control)

## Equipment

When you ordered your BMW motorcycle, you chose various items of custom equipment. This Rider's Manual describes optional extras (OE) offered by BMW and selected optional accessories (OA). This explains why the manual may also contain descriptions of equipment which you have not ordered. Please note, too, that your motorcycle might not be exactly as illustrated in this manual on account of country-specific differences. If your BMW was supplied with equipment not described in this Rider's Manual, you will

find these features described in separate manuals.

## Technical data

All dimensions, weights and power ratings stated in the Rider's Manual are quoted to the standards and comply with the tolerance requirements of the Deutsches Institut für Normung e.V. (DIN). Versions for individual countries may differ.

## Currency

The high safety and quality standards of BMW motorcycles are maintained by constant development work on designs, equipment and accessories. Because of this, your motorcycle may differ from the information supplied in the Rider's Manual. Nor can BMW Motorrad entirely rule out errors and omissions. We hope you will appreciate that no claims can be entertained on

the basis of the data, illustrations or descriptions in this manual.



## General views

General view, left side.....	11
General view, right side .....	13
Handlebar fitting, left .....	14
Handlebar fitting, right .....	16
Underneath the seat .....	17
Instrument panel .....	18
Headlight .....	19



## General view, left side

- 1 Adjuster, spring preload, front (⇒ 65)
- 2 Adjustment of windscreen (⇒ 62)
- 3 Adjuster for headlight beam throw (underneath the instrument panel) (⇒ 72)
- 4 Clutch-fluid reservoir (⇒ 114)
- 5 Type plate (on frame, behind side cover)
- 6 Seat lock (⇒ 72)
- 7 Power socket (⇒ 98)
- 8 Adjuster for damping characteristic, rear suspension (⇒ 67)
- 9 Engine oil level indicator (⇒ 107)

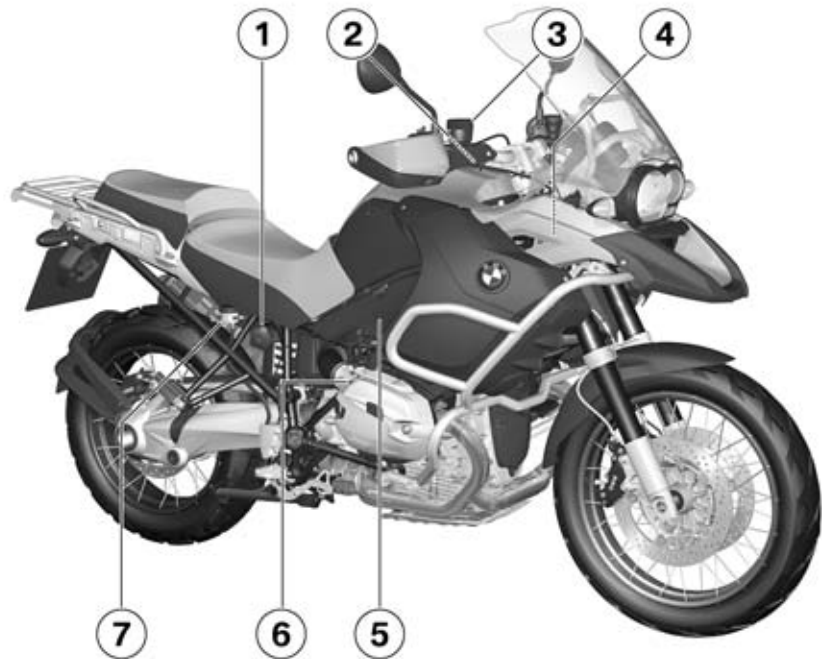

## General view, right side

- 1 Adjuster for spring preload, rear (➔ 65)
- 2 Fuel filler neck (➔ 85)
- 3 Brake-fluid reservoir, front (➔ 111)
- 4 Vehicle Identification Number (VIN) (on steering-head bearing)
- 5 Air filter (behind right side panel) (➔ 130)
- 6 Engine-oil filler neck (➔ 108)
- 7 Brake-fluid reservoir, rear (➔ 113)

## Handlebar fitting, left

- 1 Control for the odometer (→ 49)  
Operation of the clock (→ 48)  
– with on-board computer<sup>OE</sup>  
Operating the on-board computer (→ 51)  
– with auxiliary headlights<sup>OE</sup>
- 2 Operation of the auxiliary headlights (→ 55)  
– with BMW Motorrad Integral ABS II<sup>OE</sup>
- 3 Operating the ABS (→ 59)  
– with Automatic Stability Control<sup>OE</sup>
- 4 Operating ASC (→ 60)  
– with Electronic Suspension Adjustment (ESA)<sup>OE</sup>
- 5 Operating ESA (→ 68)
- 6 Horn





- 6 Flashing turn indicators,  
left (→ 56)  
Hazard warning flashers  
(→ 56)
- 7 Headlight flasher and high-  
beam headlight (→ 55)

## Handlebar fitting, right

- 1 Emergency off switch (kill switch) (→ 57)
- 2 Starter button (→ 78)
- 3 – with heated handlebar grips<sup>OE</sup>  
Grip heating control (→ 58)
- 4 Flashing turn indicators, right (→ 56)  
Hazard warning flashers (→ 56)
- 5 Cancel button, flashing turn indicators (→ 56)  
Pushbutton, cancel hazard warning flashers (→ 56)

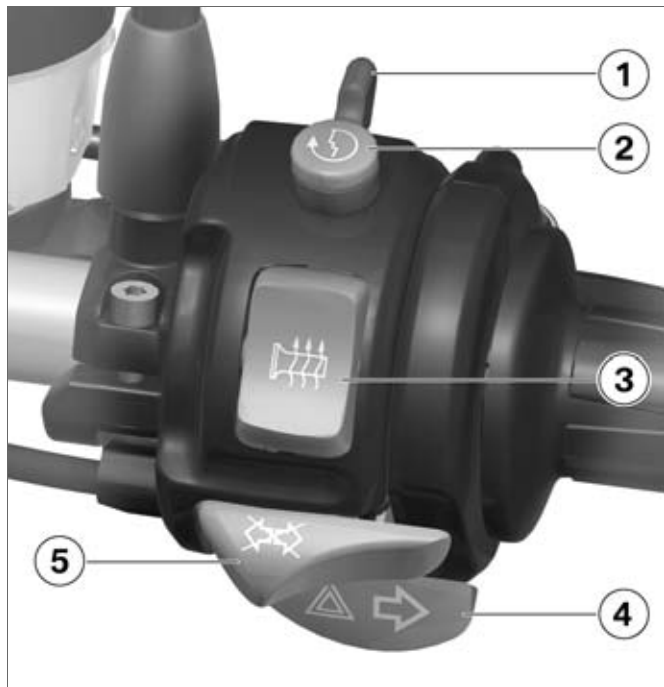

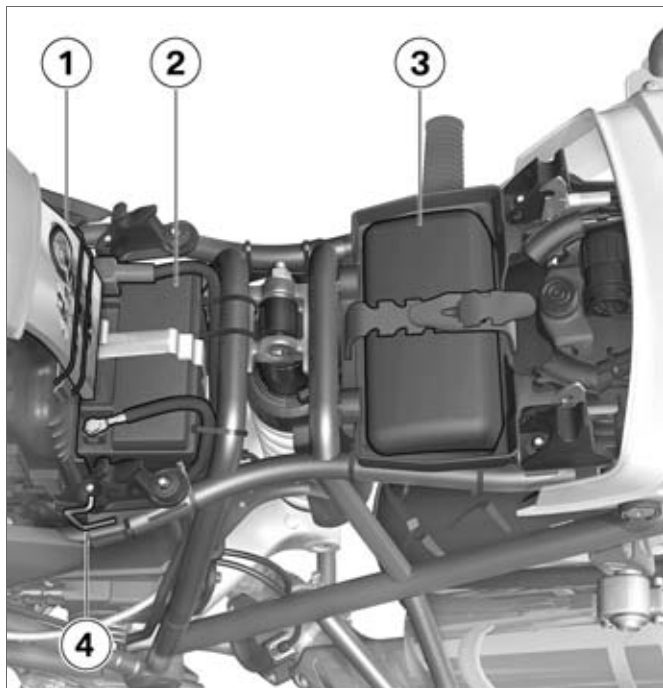

## Underneath the seat

- 1 Rider's Manual
- 2 Battery (→ 134)
- 3 Toolkit  
Payload table (in tool tray)  
Tyre pressures table (in tool tray)
- 4 Helmet holder (→ 73)

## Instrument panel

- 1 Speedometer
- 2 Rev. counter
- 3 Telltale lights (➔ 22)  
Warning lights (➔ 24)
- 4 Multifunction display  
(➔ 22)
- 5 Ambient-light brightness  
sensor (for adapting the  
brightness of the instru-  
ment lighting)  
– with anti-theft alarm  
(DWA)<sup>OE</sup>  
Anti-theft alarm telltale light  
(see the instructions for  
use for the anti-theft alarm)
- 6 Control for the odometer  
(➔ 49)  
Operation of the clock  
(➔ 48)

▶ The instrument-cluster  
lighting has automatic day  
and night switchover. ◀

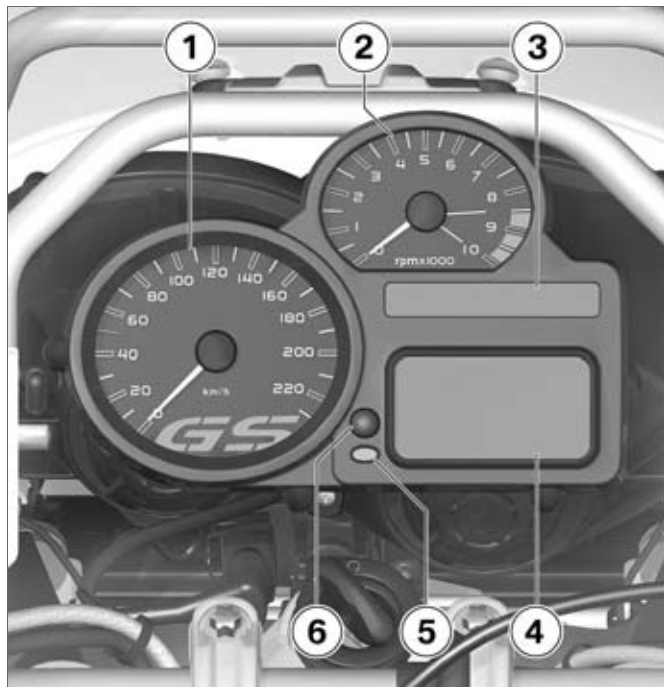

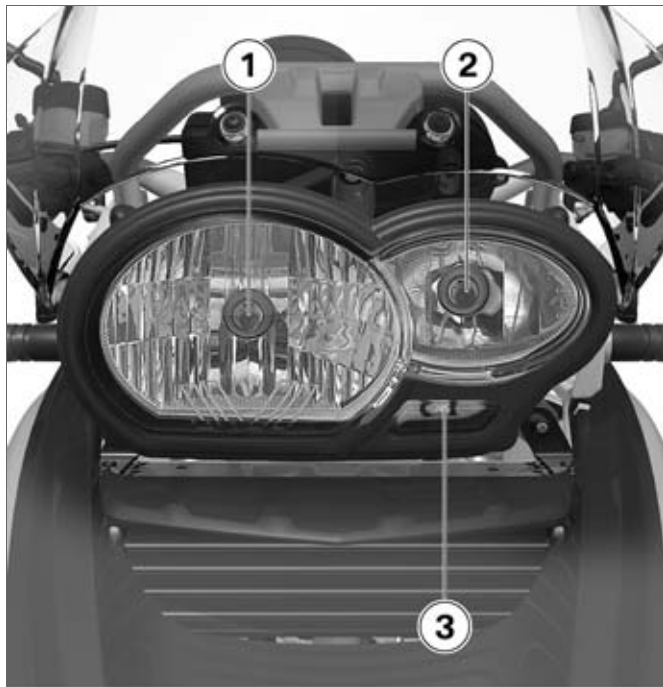

## Headlight

- 1 Low-beam headlight
- 2 High-beam headlight
- 3 Side light



Status indicators	
Standard status indicators .....	22
Status indicators with on-board computer .....	23
Status indicators with tyre pressure monitoring (RDC) .....	24
Standard warnings .....	24
Warnings issued by the on-board computer .....	29
ABS warnings .....	31
ASC warnings .....	33
RDC warnings .....	36
Anti-theft alarm warnings .....	41

## Standard status indicators

### Multifunction display

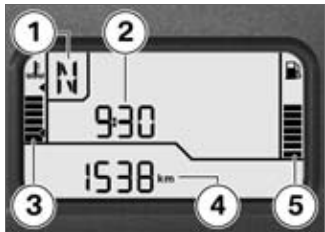

- 1 Gear indicator (⇒ 22)
- 2 Clock (⇒ 48)
- 3 Engine temperature gauge reading (⇒ 22)
- 4 Odometer and tripmeters (⇒ 49)
- 5 Fuel-gauge reading (⇒ 22)

## Telltale lights

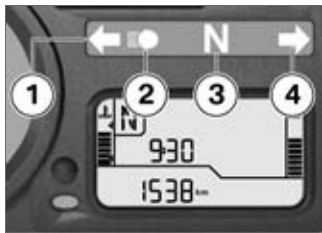

- 1 Flashing turn indicators, left
- 2 High-beam headlight
- 3 Idle
- 4 Flashing turn indicators, right

## Fuel-gauge reading

 The horizontal bars below the fuel-pump symbol indicate the remaining quantity of fuel.

Once you have refuelled, the gauge briefly shows the original

level, before the reading is updated.

## Gear indicator

 The gear engaged or N for neutral appears on the display.

 If no gear is engaged, the 'neutral' telltale light also lights up.

## Engine temperature gauge reading

 The horizontal bars below the temperature symbol indicate the engine temperature.



## Service-due indicator

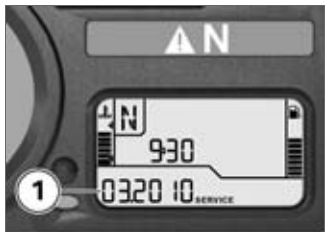

If the next service is due in less than one month, the date for the next service 1 is shown briefly after the Pre-Ride Check completes. In this example the reading means "March 2010".



If the motorcycle covers long distances in the course of the year, under certain circumstances it might be necessary to have it serviced at a date in advance of the forecast due date. If the countdown distance to the odometer reading at which a service will be due is less than 1000 km, the distance is counted down in steps of 100 km 2 and is shown briefly after the Pre-Ride Check completes.

If service is overdue, the due date or the odometer reading at which service was due is accom-

panied by the 'General' warning light showing yellow. The word "Service" remains permanently visible.

▶ If the service-due indicator appears more than a month before the service date, the date saved in the instrument cluster must be adjusted. This situation can occur if the battery was disconnected for a prolonged period of time.

If you want to have the date set consult a specialist workshop, preferably an authorised BMW Motorrad dealer. ◀

## Status indicators with on-board computer

– with on-board computer<sup>OE</sup>



- 1 Status-indicator panel of the on-board computer (→ 51)

## Status indicators with tyre pressure monitoring (RDC)

- with tyre pressure monitoring (RDC)<sup>OE</sup>



- 1 Tyre-pressure readout (→ 54)

▶ The figures shown in the tyre-pressure readings are temperature-compensated (see the section entitled "Engineering details").◀

## Standard warnings Mode of presentation



Warnings are indicated by the 'General' warning light 1 showing in combination with a warning word, for example 2 or in combination with one of the warning symbols 3. The 'General' warning light shows red or yellow, depending on the urgency of the warning.

If two or more warnings occur at the same time, all the appropriate warning lights and warning symbols appear, alternating with warning words as applicable.











The possible warnings are listed on the next page.

## Warnings, overview

## Warning light

## Status indicators

## Meaning

	Lights up yellow	EWS ! appears on the display	Electronic immobiliser active (→ 27)
	Lights up yellow	FUEL ! appears on the display	Fuel down to reserve (→ 27)
	Lights up yellow	 Appears on the display	Engine in emergency-operation mode (→ 27)
	Flashes red	 Appears on the display	Insufficient engine oil pressure (→ 28)
	Lights up red	 Appears on the display	Insufficient battery charge current (→ 28)
	Lights up yellow	LAMPR ! appears on the display	Rear light bulb defective (→ 28)
		LAMPF ! appears on the display	Front light bulb defective (→ 29)
	Lights up yellow	LAMPS ! appears on the display	Bulbs defective (→ 29)

## Electronic immobiliser active

 The "General" warning light shows yellow.

EWS ! appears on the display.  
Possible cause:

The key being used is not authorised for starting, or communication between key and engine electronics is disrupted.

- Remove all other vehicle keys from the same ring as the ignition key.
- Use the reserve key.
- Have the defective key replaced, preferably by an authorised BMW Motorrad dealer.

## Fuel down to reserve

 The "General" warning light shows yellow.

FUEL ! appears on the display.

 Lack of fuel can result in the engine misfiring and cutting out unexpectedly. Misfiring can damage the catalytic converter; a hazardous situation can result if the engine cuts out unexpectedly.

Do not run the fuel tank dry.◀

Possible cause:

The fuel tank contains no more than the reserve quantity of fuel.

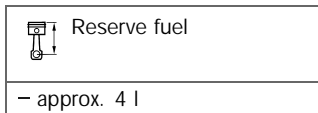

- Refuelling (➔ 85).

## Engine in emergency-operation mode

 The "General" warning light shows yellow.

 The engine symbol appears on the display.

 The engine is running in emergency operating mode. Full engine power or full engine rpm might not be available and this can cause hazardous situations, particularly if you attempt to overtake other road users. Engine power level might be lower than normal: adapt your style of riding accordingly.◀

Possible cause:

The engine control unit has diagnosed a fault. In exceptional cases, the engine stops and refuses to start. Otherwise, the engine runs in emergency operating mode.

- You can continue to ride, but bear in mind that the usual engine power might not be available.
- Avoid high load and rpm ranges if possible.
- Have the fault rectified as quickly as possible by a specialist workshop, preferably

an authorised BMW Motorrad dealer.

## Insufficient engine oil pressure

 The "General" warning light flashes red.

 The oil can symbol appears on the display.

The oil pressure in the lube-oil system is too low. Stop immediately and switch off the engine.

 The insufficient oil pressure warning does not fulfil the function of an oil gauge. The only way of checking whether the oil level is correct is to check the oil level indicator. ◀

Possible cause:

The engine-oil level is too low.

- Checking engine oil level (➔ 107).

If the oil level is too low:

- Top up the engine oil.

Possible cause:

The engine-oil pressure is insufficient.

 Riding when engine-oil pressure is low can result in engine damage.

Do not continue your journey. ◀

- Have the fault rectified as quickly as possible by a specialist workshop, preferably an authorised BMW Motorrad dealer.

## Insufficient battery charge current

 The "General" warning light shows red.

 The battery symbol appears on the display.

 A discharged battery can render various systems unavailable, for example the lights,

the engine or the ABS. This can result in dangerous situations.

If possible, do not continue your journey. ◀

Battery is not being charged. If you continue to ride the motorcycle the on-board electronics will drain the battery.

Possible cause:

Alternator or alternator drive belt defective

- Have the fault rectified as quickly as possible by a specialist workshop, preferably an authorised BMW Motorrad dealer.

## Rear light bulb defective

 The "General" warning light shows yellow.

LAMP R ! appears on the display.

Possible cause:

Rear light or brake light bulb defective.

- The LED rear light must be replaced. Consult a specialist workshop, preferably an authorised BMW Motorrad dealer.

Front light bulb defective

LAMPF ! appears on the display.



A defective bulb places your safety at risk because it is easier for other users to oversee the motorcycle. Replace defective bulbs as soon as possible; always carry a complete set of spare bulbs if possible. ◀

Possible cause:

Low-beam headlight, high-beam headlight, side-light or turn-indicator bulb defective.

- Replacing low-beam/high-beam headlight bulb (➔ 123).

- Replacing parking-light bulb (➔ 125).
- Replacing turn indicator bulbs, front and rear (➔ 126).

### Bulbs defective



The "General" warning light shows yellow.

LAMPS ! appears on the display.



A defective bulb places your safety at risk because it is easier for other users to oversee the motorcycle. Replace defective bulbs as soon as possible; always carry a complete set of spare bulbs if possible. ◀

Possible cause:

A combination of the bulb defects described above has occurred.

- See the fault descriptions above.

## Warnings issued by the on-board computer

Mode of presentation  
– with on-board computer<sup>OE</sup>

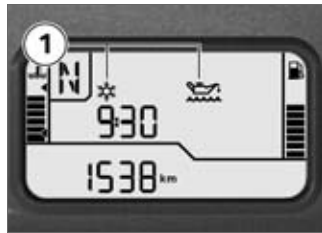

Warnings issued by the on-board computer appear as one of the symbols 1.

The possible warnings are listed on the next page.



Appears on the display

Engine-oil level too low (→ 31)

Check Oil appears on the display



Appears on the display

Ice warning (→ 31)



## Engine-oil level too low



The oil-level symbol appears on the display.

Check Oil appears on the display.

Possible cause:

The electronic oil-level sensor has registered an excessively low oil level. The next time you stop for fuel:

- Checking engine oil level (➔ 107).

If the oil level is too low:

- Top up the engine oil (➔ 108).

If the oil level is correct:

- Seek the advice of a specialist workshop, preferably an authorised BMW Motorrad dealer.

## Ice warning



The ice-crystal symbol appears on the display.

Possible cause:

The air temperature measured at the motorcycle is lower than 3 °C.



The ice warning does not mean that there is no risk of black ice forming at measured temperatures above 3 °C.

Always take extra care when temperatures are low; remember that the danger of black ice forming is particularly high on bridges and where the road is in shade.◀

- Ride carefully and think well ahead.

## ABS warnings

Mode of presentation

– with BMW Motorrad Integral ABS II<sup>OE</sup>



ABS warnings are indicated by ABS warning light 1.

The way in which the ABS warning light indicates status can differ in some countries.



Possible national variant.

The detailed descriptions relating to BMW Motorrad Integral ABS start on page (➔ 90), and you will find an overview listing the possible warnings on the next page.

## Warnings, overview

## Warning light

## Status indicators

## Meaning



Flashes

Self-diagnosis not completed (→ 33)



Lights up

ABS deactivated (→ 33)



Lights up

ABS fault (→ 33)

## Self-diagnosis not completed

 The ABS warning light flashes.

Possible cause:

The ABS function is not available, because self-diagnosis did not complete. The motorcycle has to move forward a few metres for the wheel sensors to be tested.

- Pull away slowly. Bear in mind that the ABS function is not available until self-diagnosis has completed.

## ABS deactivated

 The ABS warning light comes on.

Possible cause:

The rider has switched off the ABS system.

– with BMW Motorrad Integral ABS II<sup>OE</sup>

- Activating ABS function (➔ 59).

## ABS fault

 The ABS warning light comes on.

Possible cause:

The ABS control unit has detected a fault. The ABS function is not available.

- You can continue to ride the motorcycle, but make due provision for the fact that the ABS function is not available. Bear in mind the more detailed information on situations that can lead to an ABS fault (➔ 91).
- Have the fault rectified as quickly as possible by a specialist workshop, preferably an authorised BMW Motorrad dealer.

## ASC warnings

### Mode of presentation

– with Automatic Stability Control<sup>OE</sup>

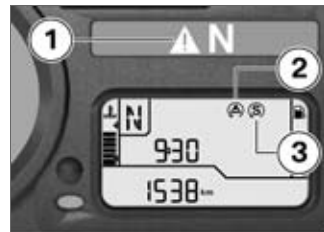

ASC warnings are indicated by ASC symbol 2 or off-road ASC symbol 3 in combination with 'General' warning light 1. The detailed descriptions relating to BMW Motorrad ASC start on page (➔ 92), and you will find an overview listing the possible warnings on the next page.

## Warnings, overview

## Warning light

## Status indicators

## Meaning

	Quick-flashes yellow		Appears on the display	ASC intervention (→ 35)
	Quick-flashes yellow		Appears on the display	Off-road ASC intervention (→ 35)
			Slow-flashes	Self-diagnosis not completed (→ 35)
			Slow-flashes	Self-diagnosis in off-road mode not completed (→ 35)
			Appears on the display	ASC deactivated (→ 35)
	Lights up yellow		Appears on the display	ASC fault (→ 36)

## ASC intervention



The "General" warning light quick-flashes yellow.



The ASC symbol appears on the display.

The ASC has detected a degree of instability at the rear wheel and has intervened to reduce torque. The warning light flashes for longer than ASC intervention lasts. This affords the rider visual feedback on control intervention even after the critical situation has been dealt with.

## Off-road ASC intervention



The "General" warning light quick-flashes yellow.



The off-road ASC symbol appears on the display.

The off-road ASC has detected a degree of instability at the rear wheel and has intervened to reduce torque. The warning light

flashes for longer than ASC intervention lasts. This affords the rider visual feedback on control intervention even after the critical situation has been dealt with.

## Self-diagnosis not completed



The ASC symbol slow-flashes.

Possible cause:

The ASC function is not available, because self-diagnosis did not complete. The motorcycle has to move forward at a speed of at least 5 km/h for the wheel sensors to be tested.

- Pull away slowly. The ASC warning light must go out within a few metres.

If the ASC warning light continues to flash:

- Seek the advice of a specialist workshop, preferably an authorised BMW Motorrad dealer.

## Self-diagnosis in off-road mode not completed



The off-road ASC symbol slow-flashes.

Possible cause:

The ASC function is not available, because self-diagnosis did not complete. The motorcycle has to move forward at a speed of at least 5 km/h for the wheel sensors to be tested.

- Pull away slowly. The ASC warning light must go out within a few metres.

If the ASC warning light continues to flash:

- Seek the advice of a specialist workshop, preferably an authorised BMW Motorrad dealer.

## ASC deactivated



The ASC symbol appears on the display.

Possible cause:

The rider has switched off the ASC system.

- with Automatic Stability Control<sup>OE</sup>
- Activating ASC function (⇒ 61).

### ASC fault



The "General" warning light shows yellow.



The ASC symbol appears on the display.

Possible cause:

The ASC control unit has detected a fault. The ASC function and the off-road ASC function are not available.

- You can continue to ride. Bear in mind that the ASC function is not available. Bear in mind the more detailed information on situations that can lead to an ASC fault (⇒ 93).

- Have the fault rectified as quickly as possible by a specialist workshop, preferably an authorised BMW Motorrad dealer.

### RDC warnings

#### Mode of presentation

- with tyre pressure monitoring (RDC)<sup>OE</sup>

The tyre-pressure readings are based on a reference tyre temperature of 20 °C (⇒ 95).◀

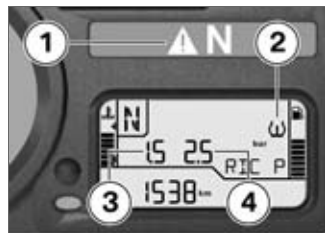

Warning symbol 2 indicates a critical tyre pressure, and the corresponding reading in the display flashes.

If the critical value is close to the limit of the permissible tolerance range, 'General' warning light 1 shows yellow. If the tyre pressure registered by the sensor is outside the permissible tolerance range, the general warning light 1 flashes red.

The tyre pressures for front wheel 3 and rear wheel 4 are shown. The graphic here indicates that the reading for the front wheel is flashing, which







means that pressure in the front tyre has reached a critical value. The detailed descriptions relating to BMW Motorrad RDC start on page (➔ 94), and you will find an overview listing the possible warnings on the next page.

## Warnings, overview

## Warning light

## Status indicators

## Meaning

	Lights up yellow		Tyre symbol appears on the display.	Tyre pressure close to limit of permitted tolerance (➔ 39)
			The critical tyre pressure flashes.	
	Flashes red		Tyre symbol appears on the display.	Tyre pressure outside permitted tolerance (➔ 39)
			The critical tyre pressure flashes.	
			"--" or "-- --" is displayed.	Signal transmission disrupted (➔ 40)
	Lights up yellow		Tyre symbol appears on the display.	Sensor defective or system error (➔ 40)
			"--" or "-- --" is displayed.	
	Lights up yellow		RDC ! appears on the display	Battery of tyre-pressure sensor weak (➔ 41)



Tyre pressure close to limit of permitted tolerance

 The "General" warning light shows yellow.

 The tyre symbol appears on the display.

The critical tyre pressure flashes.  
Possible cause:

Measured tyre pressure is close to the limit of permitted tolerance.

- Correct the tyre pressure as stated on the inside cover of the Rider's Manual.

 Before you adjust tyre pressure, read the information on temperature compensation and adjusting pressure in the section entitled "Engineering details". ◀

Tyre pressure outside permitted tolerance

 The "General" warning light flashes red.

 The tyre symbol appears on the display.

The critical tyre pressure flashes.  
Possible cause:

Measured tyre pressure is outside permitted tolerance.

- Check the tyre for damage and to ascertain whether the motorcycle can be ridden with the tyre in its present condition.

If the motorcycle can be ridden with the tyre in its present condition:

 Incorrect tyre pressures impair the motorcycle's handling characteristics.

If tyre pressure is incorrect it is essential to adapt your style of riding accordingly. ◀

- Correct the tyre pressure at the earliest possible opportunity.

 Before you adjust tyre pressure, read the information on temperature compensation and adjusting pressure in the section entitled "Engineering details". ◀

- Have the tyre checked for damage by a specialist workshop, preferably an authorised BMW Motorrad dealer.

If you are unsure whether the motorcycle can be ridden with the tyre in its present condition:

- Do not continue your journey.
- Notify the breakdown service.
- Have the tyre checked for damage by a specialist workshop, preferably an authorised BMW Motorrad dealer.

## Signal transmission disrupted

"---" or "--- ---" is displayed.

Possible cause:

The motorcycle has not yet accelerated past the threshold of approximately 30 km/h. The RDC sensors do not start transmitting signals until the motorcycle reaches a speed above this threshold for the first time (➔ 94).

- Increase speed above this threshold and observe the RDC readings. Assume that a permanent fault has not occurred unless the 'General' warning light comes on to accompany the symptoms. Under these circumstances:
- Have the fault rectified by a specialist workshop, preferably an authorised BMW Motorrad dealer.

Possible cause:

Wireless communication with the RDC sensors has been disrupted.

Possible causes include radio-communication systems operating in the vicinity and interfering with the link between the RDC control unit and the sensors.

- Move to another location and observe the RDC readings. Assume that a permanent fault has not occurred unless the 'General' warning light comes on to accompany the symptoms. Under these circumstances:
- Have the fault rectified by a specialist workshop, preferably an authorised BMW Motorrad dealer.

## Sensor defective or system error



The "General" warning light shows yellow.



The tyre symbol appears on the display.

"---" or "--- ---" is displayed.

Possible cause:

Motorcycle is fitted with wheels not equipped with RDC sensors.

- Fit wheels and tyres equipped with RDC sensors.

Possible cause:

One or two RDC sensors have failed.

- Have the fault rectified by a specialist workshop, preferably an authorised BMW Motorrad dealer.

Possible cause:

A system error has occurred.

- Have the fault rectified by a specialist workshop, preferably an authorised BMW Motorrad dealer.

## Battery of tyre-pressure sensor weak

 The "General" warning light shows yellow.

RDC ! appears on the display.

 This error message appears only briefly after the pre-ride check completes. ◀

Possible cause:

The integral battery in the tyre-pressure sensor has lost a significant proportion of its original capacity. There is no assurance of how long the tyre pressure control system can remain operational.

- Seek the advice of a specialist workshop, preferably an authorised BMW Motorrad dealer.

## Anti-theft alarm warnings

Mode of presentation

– with anti-theft alarm (DWA)<sup>OE</sup>



Anti-theft alarm warnings appear as plain-text warnings 2 in combination with the 'General' warning light 1 showing after the Pre-Ride Check and relate to the capacity of the internal battery that supplies power to the anti-theft alarm.

The possible warnings are listed on the next page.

## Warnings, overview

## Warning light

## Status indicators

## Meaning

---

	DWALO ! appears on the display	Anti-theft alarm battery weak (➡ 43)
	Lights up yellow	DWA ! appears on the display
		Anti-theft alarm battery flat (➡ 43)

---

## Anti-theft alarm battery weak

DWALO ! appears on the display.

 This error message appears only briefly after the pre-ride check completes.◀

Possible cause:

The integral battery in the anti-theft alarm has lost a significant proportion of its original capacity. There is no assurance of how long the anti-theft alarm can remain operational if the motorcycle's battery is disconnected.

- Seek the advice of a specialist workshop, preferably an authorised BMW Motorrad dealer.

## Anti-theft alarm battery flat

 The "General" warning light shows yellow.

DWA ! appears on the display.

 This error message appears only briefly after the pre-ride check completes.◀

Possible cause:

The integral battery in the anti-theft alarm has lost its entire original capacity. There is no assurance that the anti-theft alarm will be operational if the motorcycle's battery is disconnected.

- Seek the advice of a specialist workshop, preferably an authorised BMW Motorrad dealer.



## Operation

Ignition switch and steering lock . . . .	46	Windscreen . . . . .	62
Electronic immobiliser EWS . . . . .	47	Clutch . . . . .	62
Clock . . . . .	48	Brakes . . . . .	63
Odometer and tripmeters . . . . .	49	Shift mechanism . . . . .	64
On-board computer . . . . .	51	Mirrors . . . . .	64
Tyre pressure monitoring RDC . . . . .	54	Handlebars . . . . .	65
Lights . . . . .	55	Spring preload . . . . .	65
Turn indicators . . . . .	56	Damping . . . . .	67
Hazard warning flashers . . . . .	56	Electronic Suspension Adjustment ESA . . . . .	68
Emergency off switch (kill switch) . . . . .	57	Tyres . . . . .	71
Operating grip heating . . . . .	58	Headlight . . . . .	71
BMW Motorrad Integral ABS . . . . .	59	Front and rear seats . . . . .	72
Automatic Stability Control ASC . . . . .	60	Helmet holder . . . . .	73
Seat height . . . . .	61		

## Ignition switch and steering lock

### Keys

You receive two master keys and one spare key. Please consult the information on the electronic immobiliser (EWS) if a key is lost or mislaid (⇒ 47).

Ignition switch and steering lock, tank filler cap lock and seat lock are all operated with the same key.

- with aluminium case<sup>OA</sup>
- with aluminium topcase<sup>OA</sup>

If you wish you can arrange to have the cases and the topcase fitted with locks that can be opened with this key as well. Consult a specialist workshop, preferably an authorised BMW Motorrad dealer.◁

### Switching on ignition



- Turn the key to position 1.
  - » Side lights and all function circuits switched on.
  - » Engine can be started.
  - » Pre-ride check is performed. (⇒ 79)
- with BMW Motorrad Integral ABS II<sup>OE</sup>
  - » ABS self-diagnosis is performed. (⇒ 80)
- with Automatic Stability Control<sup>OE</sup>
  - » ASC self-diagnosis is performed. (⇒ 80)

### Switching off ignition



- Turn the key to position 2.
  - » Lights switched off.
  - » Handlebars not locked.
  - » Key can be removed.
  - » Electrically powered accessories remain operational for a limited period of time.
  - » The battery can be recharged via the socket.

### Locking handlebars



If the motorcycle is on the side stand, the surface of the ground will determine whether it is better to turn the handle-



bars to the left or right. However, the motorcycle is more stable on a level surface with the handlebars turned to the left than with the handlebars turned to the right.

On level ground, always turn the handlebars to the left to set the steering lock. ◀

- Turn the handlebars to the full left or right lock position.



- Turn the key to position 3, while moving the handlebars slightly.

- » Ignition, lights and all function circuits switched off.
- » Handlebars locked.
- » Key can be removed.

## Electronic immobiliser EWS

The motorcycle's electronics exchange certain continuously changing signals with the electronics in the key; these signals are specific to your motorcycle and they are transmitted via the ring aerial in the ignition lock. The ignition is not enabled for starting until the engine control unit has recognised the key as "authorised" for your motorcycle.

▶ A spare key attached to the same ring as the ignition key used to start the engine could "irritate" the electronics, in which case the enabling signal for starting is not issued.

The EWS warning appears in the multifunction display.

Always keep the spare key separately from the ignition key. ◀

If you mislay a key you can have the key in question barred by your authorised BMW Motorrad dealer. In order to have a key barred you must bring along all the other keys belonging to the motorcycle.

The engine cannot be started by a barred key, but a key that has been barred can subsequently be reactivated.

You can obtain replacement/extra keys only through an authorised BMW Motorrad dealer. The keys are part of an integrated security system, so the dealer is under an obligation to check the legitimacy of all applications for replacement/extra keys.

## Clock

### Setting clock

**!** Attempting to set the clock while riding the motorcycle can lead to accidents.

Set the clock only when the motorcycle is stationary. ◀

- Switch on the ignition.
  - without on-board computer<sup>OE</sup>
  - without tyre pressure monitoring (RDC)<sup>OE</sup>



- Repeatedly press button 1 or button 2 until the odometer

reading appears on the display. ◀

- with on-board computer<sup>OE</sup>
- or
- with tyre pressure monitoring (RDC)<sup>OE</sup>



- Repeatedly press button 2 until the clock appears on the display. ◀

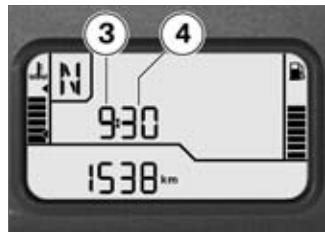

- Press and hold down the button until the hours number 3 flashes.
- Repeatedly press the button until the hours number is correct.
- Press and hold down the button until the minutes number 4 flashes.
- Repeatedly press the button until the minutes number is correct.
- Hold down the button until the minutes number stops flashing.
- » This completes the process.

## Odometer and tripmeters

### Select the readings

- Switch on the ignition.
- without on-board computer<sup>OE</sup>
- without tyre pressure monitoring (RDC)<sup>OE</sup>



- Press button 1 or button 2.<

- with on-board computer<sup>OE</sup>
- or
- with tyre pressure monitoring (RDC)<sup>OE</sup>



- Press button 1.<



- Repeatedly press the button until the value you want appears in panel 3.

The following values can be displayed:

- Total distance covered
  - Tripmeter 1 (Trip I)
  - Tripmeter 2 (Trip II)
  - without on-board computer<sup>OE</sup>
- Residual range (once fuel level is down to reserve)

### Resetting tripmeter

- Switch on the ignition.
- Select the desired tripmeter.

- without on-board computer<sup>OE</sup>
- without tyre pressure monitoring (RDC)<sup>OE</sup>



- Press and hold down button 1 or button 2 until the tripmeter reading is reset.<

- with on-board computer<sup>OE</sup> or
- with tyre pressure monitoring (RDC)<sup>OE</sup>

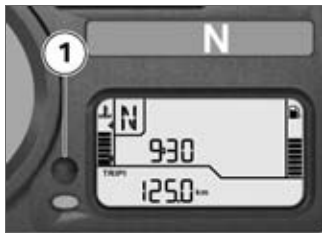

- Press and hold down button 1 until the tripmeter reading is reset.<

### Residual range

- without on-board computer<sup>OE</sup>

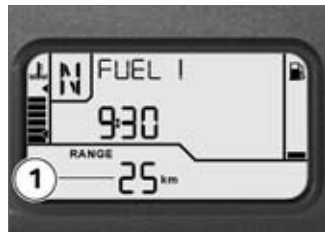

The residual-range readout 1 indicates how far you can ride with the fuel remaining in the tank. This reading is not displayed until fuel level has dropped to reserve. This distance is calculated on the basis of fuel level and average consumption.

When refuelling after running on reserve, make sure that you top up the tank to a level above reserve, as otherwise the sensor will not be able to register the new level. If the sensor cannot register the new level the residual-range readout cannot be updated.

 The calculated range is an approximate value. Consequently, BMW Motorrad recommends that you should not try to use the full residual range before refuelling. ◀

## On-board computer

– with on-board computer<sup>OE</sup>

### Select the readings

- Switch on the ignition.



- Repeatedly press button 1 until the reading shows the value you want.

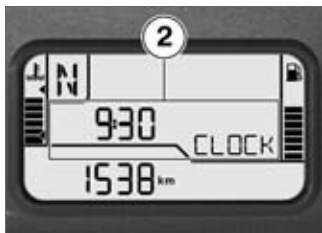

The following values can be displayed in panel 2:

- Clock (CLOCK)
- Ambient temperature (TEMP)
- Average speed (ØSPEED)
- Average fuel consumption (ØFUEL)
- Range (RANGE)
- Oil-level reminder (OIL)
- with tyre pressure monitoring (RDC)<sup>OE</sup>

Tyre pressures (RDC P)

## Ambient temperature

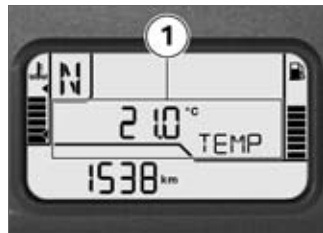

When the motorcycle is at a standstill the heat of the engine can falsify ambient-temperature reading 1. If the effect of the engine's heat becomes excessive, -- temporarily appears on the display.

 If ambient temperature drops below 3 °C this warning appears, drawing your attention to the risk of black ice forming. The display automatically switches from any other mode to the temperature reading when the temperature

drops below this threshold for the first time.◁

## Average speed



Average speed 1 is calculated on the basis of the time elapsed since the last reset. Times during which the engine was stopped are excluded from the calculation.

### Resetting average speed

- Switch on the ignition.
- Select average speed.



- Press and hold down button 1 until the average-speed reading is reset.

## Average consumption



Average consumption 1 is calculated by dividing the distance covered since the last reset by the corresponding amount of fuel used.

### Resetting average consumption

- Switch on the ignition.
- Select average consumption.



- Press and hold down button 1 until the average-consumption reading is reset.

## Range



The description of the residual-range function (→ 50) also covers range readout 1. You can also view the range before the fuel level drops to reserve.

A special average-consumption figure is used to calculate range; this figure is not necessarily the same as the value you can call up for viewing on the display. When the motorcycle is propped on its side stand the slight angle of inclination means that the sensor cannot register the fuel level correctly. This is the reason why the range is calculated only

when the motorcycle is on the move.

▶ The calculated range is only an approximate reading. Consequently, BMW Motorrad recommends that you should not try to use the full range before refuelling.◀

## Oil level



Oil-level indicator 1 gives you an indication of the engine oil level. You can call up this reading only when the motorcycle is at a standstill.

The preconditions for the oil level check are as follows:

- Engine at operating temperature.
- Engine idling for at least ten seconds.
- Side stand retracted.
- Make sure the motorcycle is upright.

The readings mean:

OK: Oil level is correct.

CHECK: Check the oil level the next time you stop for fuel.

---: Oil level cannot be measured (conditions as stated above not satisfied).



If you call up another reading on the on-board computer, this symbol remains visible until the sensor again registers a correct oil level.

The most recently measured level is displayed for five seconds when you next switch on the ignition.



The oil-level sensor might be defective if the "Check oil level" message appears even though the oil level in the oil sight glass is correct. In this case, consult your authorised BMW Motorrad dealer. ◀

## Tyre pressure monitoring RDC

- with tyre pressure monitoring (RDC)<sup>OE</sup>

### Viewing tyre-pressure readings

- Switch on the ignition.



- Repeatedly press button 1 until the tyre-pressure readings appear on the display.



Tyre-pressure readings 2 are based on a reference tyre temperature of 20 °C. The front tyre pressure is on the left; the read-



ing on the right is the rear tyre pressure. --- appears directly after the ignition is switched on, because the sensors do not transmit tyre pressures until the first time the motorcycle accelerates to more than 30 km/h.

## Lights

### Side light

The side lights switch on automatically when the ignition is switched on.

▶ The side lights place a strain on the battery. Do not switch the ignition on for longer than absolutely necessary.◀

### Low-beam headlight

The low-beam headlight switches on automatically when you start the engine.

▶ When the engine is not running you can switch on the lights by switching on the ignition and either switching on the high-beam headlight or operating the headlight flasher.◀

### High-beam headlight and headlight flasher



- Press top section of switch 1 to switch on the high-beam headlight.
- Press bottom section of switch 1 to operate the headlight flasher.

### Parking light

- Switch off the ignition.



- Immediately after switching off the ignition, push button 1 and hold it in this position until the parking lights come on.
- Switch the ignition on and off again to switch off the parking lights.

### Auxiliary headlights

– with auxiliary headlights<sup>OE</sup>



- Press left section of switch 1 to switch on the auxiliary headlights.
- Press right section of switch 1 to switch off the auxiliary headlights.

▷ The LED auxiliary headlights available as optional accessories have an overheat cutout. The headlights automatically reduce their brightness if a certain temperature is reached; under extreme circumstances the headlights can even switch themselves off. The headlights return

to full brightness once they have cooled down sufficiently. ◀

## Turn indicators

### Operating flashing turn indicators

- Switch on the ignition.

▷ The turn indicators are cancelled automatically after you have ridden for approximately 10 seconds, or covered a distance of about 200 m. ◀



- Press button 1 to switch on the left flashing turn indicator.



- Press button 2 to switch on the right flashing turn indicator.
- Press button 3 to switch off the flashing turn indicators.

## Hazard warning flashers

### Operating hazard warning flashers

- Switch on the ignition.

▷ The hazard warning flashers place a strain on the battery. Do not use the hazard warning flashers for longer than absolutely necessary. ◀

▶ If you press a turn-indicator button with the ignition switched on, the turn-indicator function is activated instead of the hazard warning flashers, and remains active until you release the button. The hazard warning flashers recommence flashing as soon as the button is released. ◀



- Press buttons 1 and 2 at the same time to switch on the hazard warning flashers.
- » Ignition can be switched off.



- Press button 3 to switch off the hazard warning flashers.

## Emergency off switch (kill switch)



- 1 Emergency off switch (kill switch)

**!** Operating the kill switch when riding can cause the rear wheel to lock and thus cause a fall. Do not operate the kill switch when riding. ◀

The emergency off switch is a kill switch for switching off the engine quickly and easily.

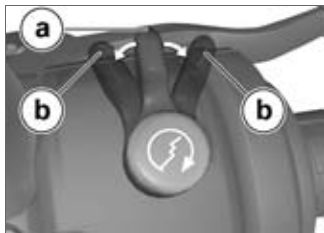

a Normal operating position (run)

b Engine switched off.

▶ You cannot start the engine unless the kill switch is in the run position.◀

## Operating grip heating

– with heated handlebar grips<sup>OE</sup>

- Start the engine.

▶ The increase in power consumption caused by the grip heating can drain the battery if you are riding at low engine speeds. If the charge level

is low, grip heating is switched off to ensure the battery's starting capability.◀



- Set switch 1 to the desired heating stage.

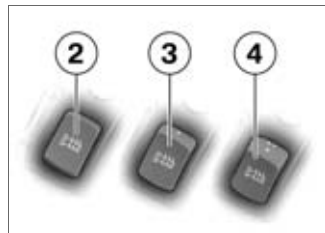

The handlebar grips have two-stage heating. Stage two is for heating the grips quickly: it is advisable to switch back to stage one as soon as the grips are warm. Grip heating can be activated only when the engine is running.

- 2 No dot visible: heating off.
- 3 one dot visible: 50% heat output.
- 4 three dots visible: 100% heat output.

## BMW Motorrad Integral ABS

- with BMW Motorrad Integral ABS II<sup>OE</sup>

### Deactivating ABS function

- Bring the motorcycle to a stop or, if the motorcycle is at a standstill, switch on the ignition.



- Press and hold down button 1 until the ABS warning light changes status.



The ABS warning light comes on.

- with Automatic Stability Control<sup>OE</sup>
  - » Initially, the ASC symbol changes status. Press and hold down button 1 until the ABS warning light responds. Under these circumstances there is no change in the ASC setting.
- Release button 1 within two seconds.



The ABS warning light remains ON.

- » The ABS function is deactivated, but the integral function remains active.

### Response with ABS deactivated

If you deactivate the ABS, the function is initially disabled for the front wheel only. If you subsequently apply the brakes by pulling only the handbrake lever,

the Integral function ensures that the rear wheel is also braked and ABS control remains active for the rear wheel. ABS control for the rear wheel is not deactivated until you depress the footbrake lever.

### Activating ABS function



- Press and hold down button 1 until the ABS warning light changes status.



The ABS warning light goes out; if self-diagnosis has not completed it starts flashing.

- Release button 1 within two seconds.

 The ABS warning light remains off or continues to flash.

- » The ABS function is activated.
- You also have the option of switching the ignition off and then on again.

 If you switch the ignition off then on again and the ABS light comes back on, there is a fault in the ABS. ◀

## Automatic Stability Control ASC

– with Automatic Stability Control<sup>OE</sup>

### Operation

The BMW Motorrad ASC system can be deactivated and activated and switched to an off-road mode (➔ 93) for riding on

pebbly or gravely surfaces and on loose sand.

ASC is active when the ASC symbol does not show.

 This symbol appears on the display to indicate that ASC is active in off-road mode.

 This symbol appears on the display to indicate that ASC has been deactivated.

Sequence of operations:

- Switch from ASC to off-road ASC
- Deactivate ASC
- Activate ASC

### Switching and deactivating ASC function

- Switch on the ignition.

 You have the option of deactivating the ASC function while the motorcycle is on the move. ◀



- To switch to offroad ASC, press and hold down button 1 until the ASC symbol changes status.

 The off-road ASC symbol appears on the display; if self-diagnosis has not completed the off-road ASC symbol flashes.

- Release button 1 within two seconds.

 The off-road ASC symbol remains visible or continues to flash.

- » The off-road ASC function is activated.

- To switch off ASC, press and hold down button 1 until the ASC symbol changes status.

 The ASC symbol appears on the display.

- Release button 1 within two seconds.

 The ASC symbol continues to show.

- » The ASC function is deactivated.

## Activating ASC function



- Press and hold down button 1 until the ASC symbol changes status.

 The ASC symbol no longer shows; if ASC self-diagnosis has not completed the ASC symbol flashes.

- Release button 1 within two seconds.

 The ASC symbol still does not show or continues to flash.

- » The ASC function is activated.

- You also have the option of switching the ignition off and then on again.

 An ASC fault has occurred if the ASC warning light shows when the motorcycle accelerates to a speed in excess of 5 km/h after the ignition was switched off and then on again. ◀◀

## Seat height

### Adjusting seat height

- Remove the front seat (→ 72).
- Turn the front seat upside down.

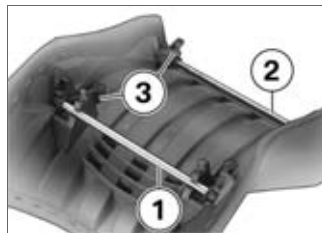

- Remove seat rods 1 and 2 from holders 3.

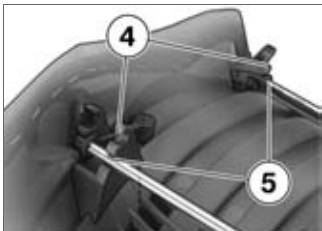

**!** The front seat can work loose and wobble if the two seat rods are not in the same position.

Always be sure to install both seat rods in the same position. ◀

- Re-insert the seat rods in the desired position.
- » Position 4: seat in high position
- » Position 5: seat in low position
- Install the front seat (➔ 73).

## Windscreen

### Adjusting windscreen



- Slacken clamping screws 1 on left and right.
- Pivot the windscreen forward or back to the desired position.
- Make sure that the windscreen settings are the same on left and right.
- Tighten the clamping screws on left and right.

## Clutch

### Adjusting clutch lever

**!** If the position of the clutch fluid reservoir is changed, air can enter the clutch system. Do not twist the handlebar fitting or the handlebars. ◀

**!** Attempting to adjust the clutch lever while riding the motorcycle can lead to accidents. Do not attempt to adjust the clutch lever unless the motorcycle is at a standstill. ◀



- Turn adjusting screw 1 clockwise to increase the span



between the clutch lever and the handlebar grip.

- Turn adjusting screw 1 counter-clockwise to reduce the span between the clutch lever and the handlebar grip.

 The adjusting screw is easier to turn if you push the clutch lever forward.◀

## Brakes

### Adjust the handbrake lever

 Changing the position of the brake-fluid reservoir can allow air to penetrate the brake system.

Do not twist the handlebar fitting or the handlebars.◀

 Attempting to adjust the handbrake lever while riding the motorcycle can lead to accidents.

Do not attempt to adjust the

handbrake lever unless the motorcycle is at a standstill.◀



- Turn adjusting screw 1 clockwise to increase the span between the brake lever and the handlebar grip.
- Turn adjusting screw 1 counter-clockwise to reduce the span between the brake lever and the handlebar grip.

 The adjusting screw is easier to turn if you push the handbrake lever forward.◀

### Adjust the footbrake lever

- Make sure the ground is level and firm and place the motorcycle on its stand.



- Push footplate 1 of the footrest forward to disengage.



- Push the footplate up until it locks for riding seated.



- Push the footplate down until it locks for riding upright.

## Shift mechanism

### Adjusting shift lever

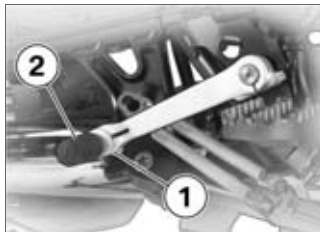

- Slacken screw 1.
- Turn peg 2 to the desired position.

▶ You might experience difficulties with gearshifts if the peg is set either too high or too low. Check the setting of the peg if you experience gearshift difficulties.◀

- Tighten screw 1 to the specified tightening torque.



Peg to gearshift lever

– 8 Nm

## Mirrors

### Adjusting mirrors



- Turn the mirror to the correct position.

## Adjusting mirror arm



- Push protective cap 1 up over the threaded fastener on the mirror arm.
- Slacken nut 2.
- Turn the mirror arm to the appropriate position.
- Tighten the nut to the specified tightening torque, while holding the mirror arm to ensure that it does not move out of position.



Mirror to adapter

– 22 Nm

- Push the protective cap over the threaded fastener.

## Handlebars

### Adjusting handlebars

You can turn the handlebar clamping blocks 180° to increase or decrease handlebar reach.



Short-reach position, handlebars toward rider.



Long-reach position, handlebars away from rider.

If you want to have the handlebars adjusted consult a specialist workshop, preferably an authorised BMW Motorrad dealer.

## Spring preload

### Setting

It is essential to set spring preload of the front suspension to suit the terrain. Increase spring preload for riding in rough terrain and reduce if the terrain is level.

It is essential to set spring preload of the rear suspension to suit the load carried by the motorcycle. Increase spring preload when the motorcycle is heavily loaded and reduce spring preload accordingly when the motorcycle is lightly loaded.

### Adjusting spring preload for front wheel

**!** Your motorcycle's handling will suffer if you do not match the spring-preload and damping-characteristic settings. Adjust the damping characteristic to suit spring preload.◀

- Make sure the ground is level and firm and place the motorcycle on its stand.

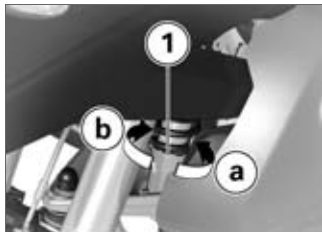

- If you want to reduce spring preload, use the tool from the on-board toolkit to turn spring retainer 1 in direction a.
- If you want to increase spring preload, use the tool from the on-board toolkit to turn the spring retainer in direction b.



Spring preload at front wheel

- without Electronic Suspension Adjustment (ESA)<sup>OE</sup>
- Spring preload at setting 2 (On-road riding)



Spring preload at front wheel

- Spring preload at setting 3 (For riding on gravel tracks and similar and with load)
- Spring preload at setting 5 (For riding off-road)◀

### Adjusting spring preload for rear wheel

- Make sure the ground is level and firm and place the motorcycle on its stand.



- If you want to increase spring preload, turn knob 1 in the direction indicated by the HIGH arrow.



Basic setting of spring preload, rear

- without Electronic Suspension Adjustment (ESA)<sup>OE</sup>
- Turn the knob as far as it will go in the LOW direction, then preload the spring by 10 clicks. (Full load of fuel, with rider 85 kg)◀

**!** Your motorcycle's handling will suffer if you do not match the spring-preload and damping-characteristic settings. Adjust the damping characteristic to suit spring preload.◀

**!** Adjusting spring preload while the motorcycle is being ridden can lead to accidents. Do not attempt to adjust spring preload unless the motorcycle is at a standstill.◀

- If you want to reduce spring preload, turn knob 1 in the direction indicated by the LOW arrow.



- You can ascertain the current setting by counting the number of slots that are visible (five when the adjuster is at the LOW stop).

## Damping Setting

Damping must be adapted to suit the surface on which the motorcycle is ridden and to suit spring preload.

- An uneven surface requires softer damping than a smooth surface.

- An increase in spring preload requires firmer damping, a reduction in spring preload requires softer damping.

## Adjusting damping for rear wheel

- Make sure the ground is level and firm and place the motorcycle on its stand.



**!** There is a risk of injury by burns if you adjust the damping characteristic while the silencer is hot.

Use a screwdriver extension and wear protective gloves. ◀

- Adjust the damping characteristic, using the tool from the on-board toolkit to turn adjusting screw 1.

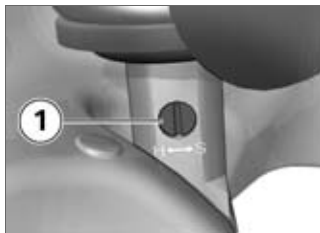

- If you want a softer damping characteristic, use a screwdriver to turn adjusting screw 1 in the direction indicated by the S arrow.
- If you want a harder damping characteristic, use a screwdriver to turn adjusting screw 1 in the direction indicated by the H arrow.



Basic setting of rear-suspension damping characteristic

- without Electronic Suspension Adjustment (ESA)<sup>OE</sup>

- Turn the adjusting screw as far as it will go in the direction indicated by the H arrow and then turn it back one and a half turns in the direction indicated by the S arrow (Full load of fuel, with rider 85 kg) ◀

## Electronic Suspension Adjustment ESA

- with Electronic Suspension Adjustment (ESA)<sup>OE</sup>

### Possible adjustments

Electronic Suspension Adjustment ESA provides a convenient way of adapting the motorcycle to the load it carries and the sur-

face over which you intend riding. You can adapt the suspension settings for on-road or off-road riding.

Three spring-preload stages can be combined with any of three damper settings for road riding, while two spring-preload stages can be paired with any of three damper settings for off-roading. The detailed description of the ESA Electronic Suspension Adjustment system starts on page (➔ 95).

### Calling up settings

- Switch on the ignition.



- Press button 1 to view the current setting.



The damping characteristic is shown in panel 1 of the multi-function display, and spring preload in panel 2.

» The setting shows briefly, then disappears automatically.

### Adjust the suspension damping

- Switch on the ignition.

▶ You can adjust the damping characteristic while the motorcycle is on the move. ◀



- Press button 1 to view the current setting.
- Repeatedly press button 1 until the setting you want to use appears on the display.

If a road-riding mode has been selected the following can be displayed:

- COMF: comfort mode
- NORM: normal mode
- SPORT: sport mode

If an off-riding stage for off-road riding has been selected the following can be displayed:

- SOFT: Soft damping characteristic
- NORM: normal mode
- HARD: Hard damping characteristic

» The setting shown on the display is automatically accepted as the damping characteristic if you allow a certain length of time to pass without pressing button 1. The ESA setting then automatically disappears from the display.

## Adjust spring preload

- Start the engine.

 You cannot adjust spring preload while the motor-cycle is on the move.◀

- Wait until adjustment completes (reading stops flashing) before pulling away.
- If the temperature is very low, take the weight off the motor-cycle before increasing spring preload; if applicable, have your passenger dismount.





- Press button 1 to view the current setting.

- Repeatedly press button 1 until the setting you want to use appears on the display.

The following can be displayed:

 One-up

 One-up with luggage

 Two-up (with luggage)

The possible settings for off-road riding then appear on the display. The riding modes you can select also change accordingly.

 Predominantly smooth terrain

 Uneven terrain

» The settings shown on the display are automatically accepted as the spring preload and, if applicable, the damping char-



acteristic if you allow a certain length of time to pass without pressing button 1. The reading flashes while spring preload adjustment is in progress. The ESA setting then automatically disappears from the display.

## Tyres

### Checking tyre pressure



Incorrect tyre pressures impair the motorcycle's handling characteristics and increase the rate of tyre wear.

Always check that the tyre pressures are correct. ◀





At high road speeds, tyre valves installed perpendicular to the wheel rim have a tendency to open as a result of centrifugal force.

In order to avoid a sudden loss of tyre pressure, fit a valve cap with rubber sealing ring to the rear

tyre and make sure that the cap is screwed on firmly. ◀

- Make sure the ground is level and firm and place the motorcycle on its stand.
- Check tyre pressures against the data below.

	Tyre pressure, front
– 2.2 bar (one-up, tyre cold)	
– 2.5 bar (two-up and/or with luggage, tyre cold)	
	Tyre pressure, rear
– 2.5 bar (one-up, tyre cold)	
– 2.9 bar (two-up and/or with luggage, tyre cold)	

If tyre pressure is too low:

- Correct tyre pressure.

## Headlight

### Adjustment for driving on right/driving on left

If the motorcycle is ridden in a country where the opposite rule of the road applies, its asymmetric low-beam headlight will tend to dazzle oncoming traffic.

Have the headlight set accordingly by a specialist workshop, preferably an authorised BMW Motorrad dealer.

### Headlight beam throw and spring preload

Headlight beam throw is generally kept constant when spring preload is adjusted to suit load. Spring preload adjustment might not suffice only if the motorcycle is very heavily loaded. Under these circumstances, headlight beam throw has to be adjusted to suit the weight carried by the motorcycle.

▶ Consult a specialist workshop, preferably an authorised BMW Motorrad dealer, if you are unsure whether the headlight basic setting is correct. ◀

## Headlight beam-throw adjustment



1 Headlight beam-throw adjustment

Spring preload adjustment might not suffice if the motorcycle is very heavily loaded. Moving the pivot lever adjusts headlight

beam throw so as not to dazzle oncoming traffic.



a Neutral position  
b Position for heavy load

## Front and rear seats

### Remove the rear seat

- Make sure the ground is level and firm and place the motorcycle on its stand.

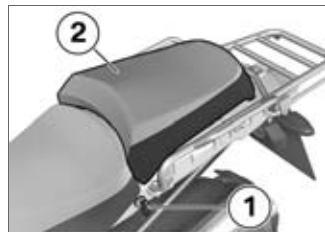

- Turn the key clockwise in seat lock 1 and hold it in this position while pressing down the front part of rear seat 2.
- Lift the rear seat at the front and release the key.
- Remove the rear seat and place it, upholstered side down, on a clean surface.

### Remove the front seat

- Remove the rear seat (→ 72).

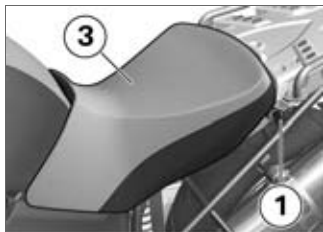

- Turn the key counter-clockwise in seat lock 1 and hold it in this position while pressing down the rear part of front seat 3.
- Lift the front seat at the rear and release the key.
- Remove the front seat and place it, upholstered side down, on a clean surface.

## Install the front seat

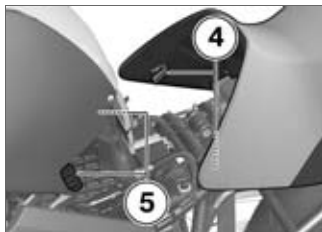

- Position the front seat with mounts 4 in holders 5 on left and right and lay it down lightly on the motorcycle.
- Applying pressure to the rear of the seat, push the front seat slightly forward and then press the seat firmly down.
  - » The front seat engages with an audible click.
- Install the rear seat (➔ 73).

## Install the rear seat

- Install the front seat (➔ 73).

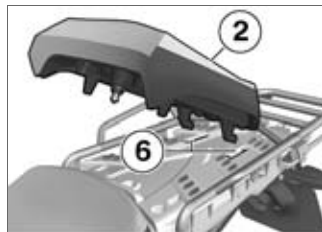

- Engage rear seat 2 in mount 6.
- Push down firmly on the rear seat, applying pressure to the front of the seat.
  - » The rear seat engages with an audible click.

## Helmet holder

### Securing helmet to motorcycle

- Remove the front seat (➔ 72).



 The helmet catch can scratch the panelling.

Make sure the lock is out of the way when you hook the helmet into position. ◀

- Attach the helmet to helmet holder 1 by means of the chin strap.
- Install the front seat (➔ 73).

Riding	
Safety instructions .....	76
Checklist .....	78
Starting .....	78
Running in .....	81
Off-roading .....	82
Brakes .....	83
Parking your motorcycle .....	84
Refuelling .....	85
Secure the motorcycle for transportation .....	86

## Safety instructions

### Rider's equipment

Do not ride without the correct clothing. Always wear:

- Helmet
- Motorcycling jacket and trousers
- Gloves
- Boots

This applies even to short journeys, and to every season of the year. Your authorised BMW Motorrad dealer will be glad to advise you on the correct clothing for every purpose.

### Loading



Overloading and imbalanced loads can adversely affect the motorcycle's handling. Do not exceed the permissible gross weight and be sure to comply with the instructions on loading. ◀

- Set spring preload, damping characteristic and tyre pressures to suit total weight.
  - with aluminium case<sup>OA</sup>
- Make sure that the weight is uniformly distributed between right and left.
- Pack heavy items at the bottom and toward the inboard side.
- Note the maximum permissible payload of the cases and the speed limit for riding with cases on the motorcycle.



Payload of aluminium cases

– see label in case



Maximum permissible speed for riding with aluminium cases fitted to the motorcycle

– see label in case ◀

- with aluminium topcase<sup>OA</sup>
- Note the maximum permissible payload of the topcase and the speed limit for riding with a topcase on the motorcycle.



Payload of aluminium topcase



– see label in topcase



Maximum permissible speed for riding with aluminium topcase fitted to the motorcycle

– see label in topcase ◀

- with tank rucksack<sup>OA</sup>
- Note the maximum permissible payload of the tank rucksack and the speed limit for riding with a tank rucksack on the motorcycle.

 Payload of tank rucksack
– ≤5 kg
 Maximum permissible speed for riding with the tank rucksack fitted to the motorcycle
– ≤130 km/h◁

## Speed

If you ride at high speed, always bear in mind that various boundary conditions can adversely affect the handling of your motorcycle:

- Settings of the spring-strut and shock-absorber system
- Imbalanced load
- Loose clothing
- Insufficient tyre pressure
- Poor tyre tread
- Etc.

## Maximum speed with massive-bar tyres

 The motorcycle's top speed might be higher than the maximum speed permitted for the tyres. Excessive speeds can damage the tyres and this could cause accidents. Comply with the tyre-specific speed restrictions.◀

Always bear the maximum permissible top speed of the tyres in mind when riding a motorcycle fitted with massive-bar tyres. Affix a label stating the maximum permissible speed in the rider's field of vision.

## Risk of poisoning

Exhaust fumes contain carbon monoxide, which is colourless and odourless but highly toxic.

 Inhaling the exhaust fumes therefore represents a health hazard and can even

cause loss of consciousness with fatal consequences.

Do not inhale exhaust fumes.

Do not run the engine in an enclosed space.◀

## Catalytic converter

If misfiring causes unburned fuel to enter the catalytic converter, there is a danger of overheating and damage.

For this reason, observe the following points:

- Do not run the fuel tank dry.
- Do not attempt to start or run the engine with a spark-plug cap disconnected.
- Stop the engine immediately if it misfires.
- Use only unleaded fuel.
- Comply with all specified maintenance intervals.

 Unburned fuel will destroy the catalytic converter.

Note the points listed for protection of the catalytic converter. ◀

## Risk of overheating

 Cooling would be inadequate if the engine were allowed to idle for a lengthy period with the motorcycle at a standstill: overheating would result. In extreme cases, the motorcycle could catch fire.

Do not allow the engine to idle unnecessarily. Ride away immediately after starting the engine. ◀

## Tampering

 Tampering with motorcycle settings (e.g. electronic engine management unit, throttle valves, clutch) can cause damages to the components in question and lead to failure of safety-relevant functions. Damage caused in this way is not covered by the warranty.

Do not tamper with the motor-

cycle in any way that could result in tuned performance. ◀

## Checklist

Use the following checklist to check important functions, settings and wear limits before you ride off.

- Brakes
- Brake-fluid levels, front and rear
- Clutch
- Clutch fluid level
- Damping-characteristic setting and spring preload
- Tyre-tread depth and tyre pressures
- Cases correctly installed and luggage secured

At regular intervals:

- Engine oil level (every refuelling stop)
- Brake-pad wear (every third refuelling stop)

## Starting

### Side stand

You cannot start the motorcycle with the side stand extended and a gear engaged. The engine will switch itself off if you start it with the gearbox in neutral and then engage a gear before retracting the side stand.

### Gearbox

You can start the engine when the gearbox is in neutral or if you pull the clutch with a gear engaged. Do not pull the clutch until after you have switched on the ignition, as otherwise the engine will refuse to start.



## Starting engine



- Kill switch in run position a.
- Switch on the ignition.
  - » Pre-ride check is performed. (➔ 79)
  - with BMW Motorrad Integral ABS II<sup>OE</sup>
    - » ABS self-diagnosis is performed. (➔ 80)
  - with Automatic Stability Control<sup>OE</sup>
    - » ASC self-diagnosis is performed. (➔ 80)



- Press starter button 1.

▶ If ambient temperatures are very low, you might find it necessary to open the throttle slightly when starting the engine. At ambient temperatures below 0 °C, disengage the clutch after switching on the ignition. ◀

▶ The start attempt is automatically interrupted if battery voltage is too low. Recharge the battery before you start the engine, or use jump leads and a donor battery to start. ◀

» The engine starts.

» Consult the troubleshooting chart below if the engine refuses to start. (➔ 144) ◀

## Pre-ride check

The instrument panel runs a test of the 'General' warning light when the ignition is switched on: this is the "Pre-Ride-Check". The test is aborted if you start the engine before it completes.

### Phase 1

 The "General" warning light shows red.

– CHECK! appears on the display.

### Phase 2

 The "General" warning light shows yellow.

– CHECK! appears on the display.

If the 'General' warning light does not show:



Some malfunctions cannot be indicated if the 'General' warning light cannot be displayed.

Check that the 'General' warning light comes on, and that it shows red and yellow. ◀

- Have the fault rectified as quickly as possible by a specialist workshop, preferably an authorised BMW Motorrad dealer.

## ABS self-diagnosis

– with BMW Motorrad Integral ABS II<sup>OE</sup>

BMW Motorrad Integral ABS performs self-diagnosis to ensure its operability. Self-diagnosis is performed automatically when you switch on the ignition. The motorcycle has to move forward a

few metres for the wheel sensors to be tested.

### Phase 1

» Test of the diagnosis-compatible system components with the motorcycle at a standstill.



The ABS warning light flashes.

### Phase 2

» Test of the wheel sensors as the motorcycle pulls away from rest.



The ABS warning light flashes.

ABS self-diagnosis completed

» The ABS warning light goes out.

If an indicator showing an ABS fault appears when ABS self-diagnosis completes:

- You can continue to ride. Bear in mind that neither the ABS

function nor the integral braking function is available.

- Have the fault rectified as quickly as possible by a specialist workshop, preferably an authorised BMW Motorrad dealer.

## ASC self-diagnosis

– with Automatic Stability Control<sup>OE</sup>

BMW Motorrad ASC performs self-diagnosis to ensure its operability. Self-diagnosis is performed automatically when you switch on the ignition.

### Phase 1

» Test of the diagnosis-compatible system components with the motorcycle at a standstill.



The ASC symbol slowly flashes.

## Phase 2

- » Test of the diagnosis-compatible system components while the motorcycle is on the move. The motorcycle must reach a speed of at least 5 km/h in order for ASC self-diagnosis to complete.



The ASC symbol slow-flashes.

### ASC self-diagnosis completed

- » The ASC symbol no longer shows.

If an indicator showing an ASC fault appears when ASC self-diagnosis completes:

- You can continue to ride. Bear in mind that the ASC function is not available.
- Have the fault rectified as quickly as possible by a specialist workshop, preferably

an authorised BMW Motorrad dealer.

## Running in

### The first 1000 km

- While running in the motorcycle, vary the throttle opening and engine-speed range frequently; avoid riding at constant engine rpm for prolonged periods.
- Try to do most of your riding during this initial period on twisting, fairly hilly roads.
- Comply with the rpm limits for running in.



#### Running-in speeds

– <math>5500\text{ min}^{-1}</math> (Odometer reading 0...200 km)

– <math>6500\text{ min}^{-1}</math> (Odometer reading 200...400 km)



#### Running-in speeds

– <math>7500\text{ min}^{-1}</math> (Odometer reading 400...600 km)

– maximum engine rpm for short bursts (Odometer reading 600...900 km)

- Do not omit the first inspection after 500 - 1200 km.

### Brake pads

New brake pads have to bed down before they can achieve their optimum friction levels. You can compensate for this initial reduction in braking efficiency by exerting greater pressure on the levers.



New brake pads can extend stopping distance by a significant margin.

Apply the brakes in good time. ◀

## Tyres

New tyres have a smooth surface. This must be roughened by riding in a restrained manner at various heel angles until the tyres are run in. This running in procedure is essential if the tyres are to achieve maximum grip.

 Tyres do not have their full grip when new and there is a risk of accidents at extreme angles of heel.

Avoid extreme angles of heel.◀

## Off-roading

### For off-roading

– with aluminium topcase<sup>OA</sup>

It is advisable to either remove the topcase or fit the backrest cushion available as an optional accessory from your authorised BMW Motorrad dealer if you intend off-roading.<

## After off-roading

BMW Motorrad recommends checking the following after riding the motorcycle off-road:

### Tyre pressure

 Tyre pressures reduced for off-road riding impair the motorcycle's handling characteristics on surfaced roads and can lead to accidents.

Always check that the tyre pressures are correct.◀

### Brakes

 When riding on loose surfaces or muddy roads, the brakes may fail to take effect immediately because of dirt or moisture on the discs or brake pads.

Apply the brakes in good time until the brakes have been cleaned.◀

 The brake pads will wear more rapidly if you ride frequently on unsurfaced tracks or poor roads.

Check the thickness of the brake pads more frequently and replace the brake pads in good time.◀

Spring preload and shock-absorber settings

 The off-road settings for spring preload and shock absorber damping characteristic will impair the motorcycle's handling characteristics on surfaced roads.

If you have been off-roading, remember to correct spring preload and shock-absorber damping characteristics before you return to surfaced roads.◀

### Rims

BMW Motorrad recommends checking the rims for damage after off-roading.

## Air filter element



Engine damage due to clogged air filter element. If you ride in dusty terrain check the air filter element for clogging at shorter intervals; clean or replace as necessary. ◀

Operation in very dusty conditions (desert, steppes, or the like) necessitates the use of air filter elements specially designed for conditions of this nature.

## Brakes

### How can stopping distance be minimised?

Each time the brakes are applied, a load distribution shift takes place with the load shifting forward from the rear to the front wheel. The sharper the motorcycle decelerates, the more load is shifted to the front wheel. The higher the wheel load, the more

braking force can be transmitted without the wheel locking.

To optimise stopping distance, apply the front brakes rapidly and keep on increasing the force you apply to the brake lever. This makes the best possible use of the dynamic increase in load at the front wheel. Remember to pull the clutch at the same time. In the "panic braking situations" that are trained so frequently braking force is applied as rapidly as possible and with the rider's full force exerted on the brake levers; under these circumstances the dynamic shift in load distribution cannot keep pace with the increase in deceleration and the tyres cannot transmit the full braking force to the surface of the road. Under these circumstances the front wheel can lock up.

– with BMW Motorrad Integral ABS II<sup>OE</sup>

BMW Motorrad Integral ABS prevents the front wheel from locking up. ◀

### Descending mountain passes



There is a danger of the brakes fading if you use only the rear brakes when descending mountain passes. Under extreme conditions, the brakes could overheat and suffer severe damage.

Use both front and rear brakes, and make use of the engine's braking effect as well. ◀

### Wet and dirty brakes

Wetness and dirt on the brake discs and the brake pads diminish braking efficiency.

Delayed braking action or poor braking efficiency must be

reckoned with in the following situations:

- Riding in the rain or through puddles of water.
- After the motorcycle has been washed.
- Riding on salted or gritted roads.
- After work has been carried on the brakes, due to traces of oil or grease.
- Riding on dirt-covered surfaces or off-road.



Wetness and dirt result in poor braking efficiency.

Apply the brakes lightly while riding to remove wetness and dirt, or dismount and clean the brakes.

Think ahead and brake in good time until full braking efficiency is restored. ◀

## Parking your motorcycle

### Side stand

- Switch off the engine.



If the ground is soft or uneven, there is no guarantee that the motorcycle will rest firmly on the stand.

Always check that the ground under the stand is level and firm. ◀

- Extend the side stand and prop the motorcycle on the stand.



The side stand is designed to support only the weight of the motorcycle.

Do not lean or sit on the motorcycle with the side stand extended. ◀

- If the camber of the roadway permits, turn the handlebars all the way to the left.

- On a gradient, the motorcycle should always face uphill; select 1st gear.

### Centre stand

- Switch off the engine.



If the ground is soft or uneven, there is no guarantee that the motorcycle will rest firmly on the stand.

Always check that the ground under the stand is level and firm. ◀



Excessive movements could cause the centre stand to retract, and the motorcycle would topple in consequence.

Do not lean or sit on the motorcycle with the centre stand extended. ◀

- Extend the centre stand and lift the motorcycle onto the stand.

## Refuelling

 Fuel is highly flammable. A naked flame close to the fuel tank can cause a fire or explosion.

Do not smoke. Never bring a naked flame near the fuel tank. ◀

 Fuel attacks plastics, which become dull or unsightly. Wipe off plastic parts immediately if they come into contact with fuel. ◀

- Make sure the ground is level and firm and place the motorcycle on its stand.
- Open the protective cap.



- Use the ignition key to unlock the fuel filler cap and pop the cap open.



 Fuel expands when hot. Fuel escaping from an overfilled tank could make its way

onto the road surface. This could cause a fall.

Do not overfill the fuel tank. ◀

 Leaded fuel will destroy the catalytic converter. Use only unleaded fuel. ◀

- Refuel with fuel of the grade stated below; do not fill the tank past the bottom edge of the filler neck.

 When refuelling after running on reserve, make sure that you top up the tank to a level above reserve, as otherwise the sensor will not be able to register the new level. If the sensor cannot register the new level neither the fuel-level reading nor the range readout can be updated. ◀



Recommended fuel grade

- Premium plus unleaded
- 98 ROZ/RON
- 91 AKI



alternative fuel grade

- Premium unleaded (slight power- and consumption-related restrictions)
- 95 ROZ/RON
- 89 AKI
- with regular unleaded (RON 91)<sup>OE</sup>
- Regular unleaded (power- and consumption-related restrictions)
- 91 ROZ/RON
- 87 AKI◁



Usable fuel capacity

- approx. 33 l



Reserve fuel

- approx. 4 l

- Press the fuel tank cap down firmly to close.
- Remove the key and close the protective cap.

## Secure the motorcycle for transportation

- Make sure that all components that might come into contact with straps used to secure the motorcycle are adequately protected against scratching. Use adhesive tape or soft cloths, for example, for this purpose.



The motorcycle can topple and fall on its side.

Make sure that the motorcycle cannot topple sideways. ◀

- Push the motorcycle onto the transportation flat and hold it in position: do not place it on the side stand or centre stand.





Risk of damaging components.

Take care not to trap components such as brake lines or wires. ◀

- At the front, secure the straps to the handlebars on both sides.
- Pass the straps through the leading link and tighten the straps.

- At the rear, secure the straps to the rear footrests on both sides and tighten the straps.
- Tighten all the straps uniformly; the motorcycle's suspension should be compressed as tightly as possible front and rear.



## Engineering details

Brake system with BMW Motorrad Integral ABS .....	90
Electronic engine management with BMW Motorrad ASC .....	92
Tyre pressure monitoring RDC .....	94
Electronic Suspension Adjustment ESA .....	95

## Brake system with BMW Motorrad Integral ABS

– with BMW Motorrad Integral ABS II<sup>OE</sup>

### Partially integral brakes

Your motorcycle is equipped with partially integral brakes. Both front and rear brakes are applied when you pull the handbrake lever. The footbrake lever acts only on the rear brake.

While the brakes are slowing the motorcycle with ABS actively intervening, the BMW Motorrad Integral ABS adapts braking-force distribution between front and rear brakes to suit the load on the motorcycle.



The integral braking function makes it very difficult to spin the rear wheel by opening the throttle with the front brake applied to keep the motorcycle

stationary (burn-out). Attempted burn-outs can result in damage to the rear brake and the clutch. Do not attempt burn-outs. ◀

### How does ABS work?

The amount of braking force that can be transferred to the road depends on factors that include the coefficient of friction of the road surface. Loose stones, ice and snow or a wet road all have much lower coefficients of friction than a clean, dry asphalt surface. The lower the coefficient of friction, the longer the braking distance.

If the rider increases braking pressure to the extent that braking force exceeds the maximum transferrable limit, the wheels start to lock and the motorcycle loses its directional stability; a fall is imminent. Before this situation can occur, ABS intervenes and adapts braking pressure to the

maximum transferrable braking force, so the wheels continue to turn and directional stability is maintained irrespective of the condition of the road surface.

### What are the effects of surface irregularities?

Humps and surface irregularities can cause the wheels to lose contact temporarily with the road surface; if this happens the braking force that can be transmitted to the road can drop to zero. If the brakes are applied under these circumstances the ABS has to reduce braking force to ensure that directional stability is maintained when the wheels regain contact with the road surface. At this instant the BMW Motorrad Integral ABS must assume an extremely low coefficient of friction, so that the wheels will continue to rotate under all imaginable circumstances,

because this is the precondition for ensuring directional stability. As soon as it registers the actual circumstances, the system reacts instantly and adjusts braking force accordingly to achieve optimum braking.

## What feedback does the rider receive from the BMW Motorrad Integral ABS?

If the ABS system has to reduce braking force on account of the circumstances described above, vibration is perceptible through the handbrake lever.

When the handbrake lever is pulled, brake pressure is also built up at the rear wheel by the integral function. If the brake pedal is depressed after the handbrake lever is pulled, the brake pressure built up beforehand is perceptible as counter-pressure sooner than is

the case when the brake pedal is depressed either before or at the same time as the brake lever is pulled.

## Rear wheel lift

Under very severe and sudden deceleration, however, under certain circumstances it is possible that the BMW Motorrad Integral ABS will be unable to prevent the rear wheel from lifting clear of the ground. If this happens the outcome can be a highside situation in which the motorcycle can flip over.



Severe braking can cause the rear wheel to lift off the ground.

When you brake, bear in mind that ABS control cannot be relied on in all circumstances to prevent the rear wheel from lifting clear of the ground. ◀

## What is the design baseline for BMW Motorrad Integral ABS?

Within the limits imposed by physics, the BMW Motorrad Integral ABS ensures directional stability on any surface. The system is not optimised for special requirements that apply under extreme competitive situations off-road or on the track.

## Special situations

The speeds of the front and rear wheels are compared as one means of detecting a wheel's incipient tendency to lock. If the system registers implausible values for a lengthy period the ABS function is deactivated for safety reasons and an ABS fault message is issued. Self-diagnosis has to complete before fault messages can be issued. In addition to problems with the BMW Motorrad Integral ABS,

exceptional riding conditions can lead to a fault message being issued.

Exceptional riding conditions:

- Heating up with the motorcycle on the centre stand or an auxiliary stand, engine idling or with a gear engaged.
- Rear wheel locked by the engine brake for a lengthy period, for example while descending on a loose or slippery surface.

If a fault message is issued on account of exceptional riding conditions as outlined above, you can reactivate the ABS function by switching the ignition off and on again.

## What significance devolves on regular maintenance?



Invariably, a technical system cannot perform beyond the abilities dictated by its level of maintenance.

In order to ensure that the BMW Motorrad Integral ABS is always maintained in optimum condition, it is essential for you to comply strictly with the specified inspection intervals. ◀

## Reserves for safety

The potentially shorter braking distances which BMW Motorrad Integral ABS permits must not be used as an excuse for careless riding. ABS is primarily a means of ensuring a safety margin in genuine emergencies.

Take care when cornering. When you apply the brakes on a corner, the motorcycle's weight and

momentum take over and even BMW Motorrad Integral ABS is unable to counteract their effects.

## Electronic engine management with BMW Motorrad ASC

- with Automatic Stability Control<sup>OE</sup>

### How does ASC work?

The BMW Motorrad ASC compares the speed of rotation of the front wheel and the rear wheel. The differential is used to compute slip as a measure of the reserves of stability available at the rear wheel. If slip exceeds a certain limit the electronic engine management system intervenes, adapting engine torque accordingly.

## What is the design baseline for BMW Motorrad ASC?

BMW Motorrad ASC is designed as an assistant system for the rider and for use on public roads. The extent to which the rider affects ASC control can be considerable (weight shifts when cornering, items of luggage loose on the motorcycle), especially when style of riding takes rider and machine close to the limits imposed by physics.

The off-road mode can be activated for off-roading. This mode delays ASC intervention slightly in order to permit controlled drifting.

The system is not optimised for special requirements that apply under extreme competitive situations off-road or on the track. You have the option of deactivating the BMW Motorrad ASC system for these circumstances.



Even ASC is constrained by the laws of physics. Invariably, the rider bears responsibility for assessing road and traffic conditions and adopting his or her style of riding accordingly. Do not take risks that would negate the additional safety offered by this system. ◀

### Special situations

In accordance with the laws of physics, the ability to accelerate is restricted more and more as the angle of heel increases. Consequently, there can be a perceptible lag in acceleration out of very tight bends.

The speeds of the front and rear wheels are compared as one means of detecting the rear wheel's incipient tendency to spin or slip sideways. If the system registers implausible values for a lengthy period the ASC

function is deactivated for safety reasons and an ASC fault message is issued. Self-diagnosis has to complete before fault messages can be issued.

The BMW Motorrad ASC can shut down automatically under the exceptional riding conditions outlined below.

Exceptional riding conditions:

- Riding for a lengthy period with the front wheel lifted off the ground (wheelie) and ASC deactivated.
- Rear wheel rotating with the motorcycle held stationary by applying the front brake (burn-out).
- Heating up with the motorcycle on the centre stand or an auxiliary stand, engine idling or with a gear engaged.

Accelerating the motorcycle to a speed in excess of 10 km/h after switching the ignition off and then on again reactivates the ASC.<

Slip can be increased by very-heavy-duty massive-bar tyres, with the result that ASC intervention occurs before optimum forward acceleration is achieved. Under these circumstances, BMW Motorrad ASC should be deactivated.

If the front wheel lifts clear of the ground under severe acceleration, the ASC reduces engine torque until the front wheel regains contact with the ground. Under these circumstances, BMW Motorrad recommends rolling the throttle slightly closed so as to restore stability with the least possible delay.

When riding on a slippery surface, never snap the throttle twistgrip fully closed without pulling the clutch at the same time. Engine braking torque can cause the rear wheel to lock, with a corresponding loss of stability. The BMW Motorrad ASC is unable to control a situation of this nature.

## Tyre pressure monitoring RDC

– with tyre pressure monitoring (RDC)<sup>OE</sup>

### Function

A sensor integrated into each tyre measures the air temperature and the air pressure inside the tyre and transmits this information to the control unit. Each sensor has a centrifugal-force tripswitch that does not enable transmission of the measured values until the motorcycle

has accelerated to above approximately 30 km/h for the first time. The display shows -- for each tyre until the tyre-pressure signal is received for the first time. The sensors continue to transmit the measured-value signals for approximately 15 minutes after the motorcycle comes to a stop. The control unit can administer four sensors, so two different sets of wheels with RDC sensors can be alternated on the motorcycle. An error message is issued if wheels without sensors are fitted to a motorcycle equipped with an RDC control unit.<

### Tyre-pressure ranges

The RDC control unit differentiates between three tyre-pressure ranges, all of which are parameterised for the motorcycle:



- Tyre pressure within permitted tolerance.
- Tyre pressure close to limit of permitted tolerance.
- Tyre pressure outside permitted tolerance.

A warning is also issued if tyre pressure drops sharply but stays within the permitted tolerance.

## Temperature compensation

Tyre pressure is a temperature-sensitive variable: pressure increases as tyre temperature rises and decreases as tyre temperature drops. Tyre temperature depends on ambient temperature, on the style of riding and the duration of the ride.

The tyre-pressure readings shown by the multifunction display are temperature-compensated; the reference tyre temperature for these readings

is always 20 °C. The air lines available to the public in petrol stations and motorway service areas have gauges that do not compensate for temperature; the reading shown by a gauge of this nature is the temperature-dependent tyre pressure. In most instances, therefore, these gauge readings will not tally with the pressures shown by the multifunction display.◁

## Pressure adaptation

Compare the RDC readings on the multifunction display with the value in the table on the inside cover of the Rider's Manual. Then use the air line to compensate for the difference between the RDC reading and the value in the table.

Example: According to the Rider's Manual, tyre pressure should be 2.5 bar, but the reading in the multifunction display is 2.3 bar, so pressure is low by 0.2 bar. The gauge on the air line shows 2.4 bar. You must now increase tyre pressure by the 0.2 bar difference between the value in the table and the RDC reading; when the air-line gauge shows 2.6 bar, the tyre is inflated to the correct pressure.◁

## Electronic Suspension Adjustment ESA

– with Electronic Suspension Adjustment (ESA)<sup>OE</sup>

### Adjuster, spring preload

In order to ensure rapid adjustment at ambient temperatures below 0 °C, BMW Motorrad recommends adjusting the suspension to the setting for two-up riding and allowing adjustment to

complete before your passenger mounts the motorcycle.

The ESA indicator continues to flash until adjustment completes. Do not attempt to move the motorcycle until adjustment has completed.<

## Off-road settings

The Enduro ESA developed specially for the R 1200 GS incorporates the road-riding modes from other BMW models, plus special off-riding modes enabled by electro-hydraulic basic spring adjustment of the front spring strut. This convenient system of adjusting the suspension to suit very widely differing surfaces enhances the motorcycle's touring and off-riding capabilities.



In this mode, the spring preload of the front spring strut is increased to about 50 %. The rear spring base setting ad-

justs to the same position. This setting is suitable for off-riding in terrain in which large bumps or holes in the ground are unlikely to be encountered.



This setting brings spring preload of both front and rear spring struts up to maximum. It can be used, for example, in terrain where the likelihood of having to negotiate bumps and holes in the ground necessitates maximum protection against the suspension bottoming out. Ground clearance in this mode is more than in the "one-up" road-riding mode.

Not every ESA setting is suitable for every surface. Try out the various combinations of spring preload and damping until you find the settings that are best suited to your style of riding and the surface.

## Accessories

General instructions .....	98
Power sockets .....	98
Case .....	99
Topcase .....	101

## General instructions

BMW Motorrad recommends the use of parts and accessories for your motorcycle that are approved by BMW for this purpose. Genuine BMW parts and accessories and other products which BMW has approved can be obtained from your authorised BMW Motorrad dealer, together with expert advice on their installation and use.

These parts and products have been tested by BMW for safety, function and suitability. BMW accepts product liability for them. Conversely, BMW is unable to accept any liability whatsoever for parts and accessories which it has not approved.

Also bear in mind the information on the effect of wheel size on suspension-control systems (➔ 115).



BMW Motorrad cannot assess each non-BMW product to determine whether it can be used on or in connection with BMW motorcycles without constituting a safety hazard. Country-specific official authorisation does not suffice as assurance. Tests conducted by these instances cannot make provision for all operating conditions experienced by BMW motorcycles and, consequently, they are not sufficient in some circumstances.

Use only parts and accessories approved by BMW for your motorcycle. ◀

Whenever you are planning modifications, comply with all the legal requirements. Make sure that the motorcycle does not infringe the national road-vehicle construction and use regulations applicable in your country.

## Power sockets

Notes on use of power sockets:

automatic shutdown

Power sockets are shut down automatically under the following circumstances:

- If battery charge state is too low to maintain the motorcycle's start capability
- If maximum load capability as stated in the technical data is exceeded
- When the engine is being cranked on the starter

– with extra socket<sup>OA</sup>

If more than one socket is used, total current must not exceed the maximum load capability. ◀

Operating electrical accessories

You can start using electrical accessories only when the ignition is switched on. The accessory

remains operational if the ignition is subsequently switched off. The power sockets are switched off approximately 15 after the ignition is switched off, in order to prevent overloading of the on-board electrics.

### Cable routing

The cables from the power sockets to the auxiliary devices must be routed in such a way that they:

- Do not impede the rider
- Do not restrict the steering angle or obstruct handling
- Cannot be trapped

### Case

- with aluminium case<sup>OA</sup>

### Aluminium rubbings

It is advisable to stow sensitive items of luggage in a bag, in order to prevent them from becoming marked by rubbing

against the aluminium. BMW Motorrad offers a "watertight bag" as an optional accessory for use with aluminium cases and the aluminium topcase. You can obtain additional information from your authorised BMW Motorrad dealer.

### Set of carry handles

Your authorised BMW Motorrad dealer can supply a "set of carry handles" as an optional accessory to make the cases and topcase easier to carry.

These optional accessories also make good lashing points for items of luggage and the "watertight bag" optional accessory on cases and topcase.

### Opening cases

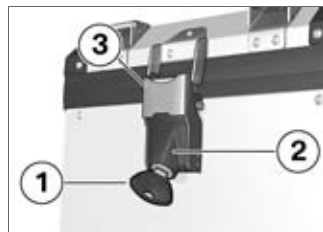

- Turn key 1 counter-clockwise.

▶ You can open the lid of the case at either catch. ◀

- Push lock housing 2 up to disengage latch toggle 3.
- Pull latch toggle 3 to the side and open the lid.

## Closing cases



- Close the case lid.
- Hold latch toggle 3 in position on the lid.
- Push lock housing 2 down, making sure that the latch toggle grips firmly in the lid.
- To secure the lock, turn the key clockwise and remove.

## Removing case lid

- Opening cases (→ 99).



- Disengage retainer 1.
- Close the case lid.
- Open the second catch of the case lid.
- Remove the case lid.

## Installing case lid

- Place the case lid on the case.
- Close one latch of the case lid.
- Using the locked side as a hinge, open the case lid.



- Engage retainer 1.
- Close the case lid.
- Close the second latch of the case lid.

## Remove the cases

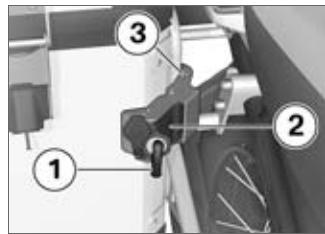

- Turn key 1 counter-clockwise.

- Push lock housing 2 to one side to disengage latch toggle 3.
- Pull latch toggle 3 to the side, while holding the case in position.

 The left case and the case carrier can become hot on long rides.

Allow the case and the case carrier to cool down before removing the case. ◀

- Pull the case forward as far as it will go and then to the side to remove.

## Installing cases

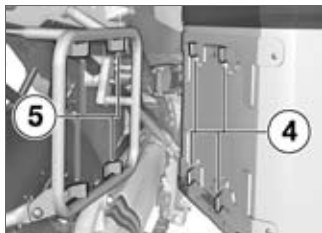

- Set the case on the case carrier and push it to the rear in such a way that mounts on case carrier 5 and on case 4 engage each other.



- Seat latch toggle 3 on the case carrier, while holding the case in position.
- Push lock housing 2 to the side, making sure that the latch toggle grips firmly on the carrier.
- Turn the key clockwise and remove.

## Topcase

– with aluminium topcase<sup>OA</sup>

## Topcase and off-roading

It is advisable to either remove the topcase or fit the backrest cushion available as an optional accessory if you intend off-roading.

### Opening topcase

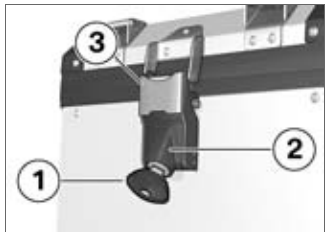

- Turn key 1 counter-clockwise.
- Push lock housing 2 up to disengage latch toggle 3.
- Pull latch toggle 3 back and open the lid.

### Closing topcase



- Close the topcase lid.
- Hold latch toggle 2 in position on the lid.
- Push lock housing 3 down, making sure that the latch toggle grips firmly in the lid.
- To secure the lock, turn the key clockwise and remove.

### Removing topcase

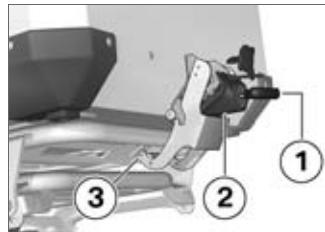

- Turn key 1 counter-clockwise.
- Push lock housing 2 down to engage latch toggle 3.
- Pull latch toggle 3 down.
- Pull the topcase to the rear and then lift it up to remove.



## Installing topcase

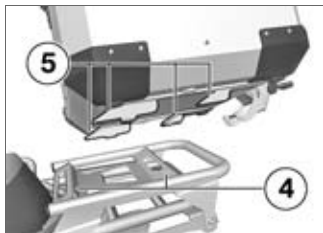

- Set the topcase on the topcase rack and push it forward in such a way that mounts on topcase rack 5 and on topcase 4 engage each other.

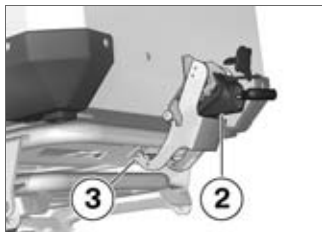

- Hold latch toggle 3 in position on the topcase carrier.
- Push lock housing 2 up, making sure that the latch toggle grips firmly on the carrier.
- To secure the lock, turn the key clockwise and remove.

### Adjustable topcase mount

The topcase mount can be installed on the luggage carrier or instead of the rear seat.

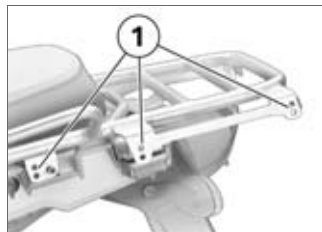

The luggage carrier has two sets of holes, one above the other, at locations 1. The topcase mount can be tilted forward or back by using holes at different heights front and back. This enables the topcase to be used as a backrest in combination with the topcase cushion available as an optional accessory.

## Repositioning topcase mount

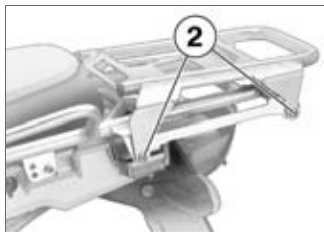

- Remove screws 2 on left and right.
- Remove the rear seat (➔ 72).

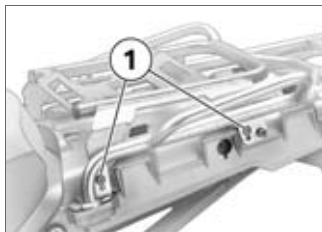

- Install the topcase mounts at the desired angle in holes 1.

Maintenance	
General instructions .....	106
Toolkit .....	106
Engine oil .....	107
Brake system .....	108
Clutch .....	114
Rims and tyres .....	114
Wheels .....	115
Front-wheel stand .....	121
Bulbs .....	123
Air filter .....	130
Jump starting .....	133
Battery .....	134

## General instructions

The "Maintenance" chapter describes straightforward procedures for checking and replacing certain wear parts.

Special tightening torques are listed as applicable. The tightening torques for the threaded fasteners on your motorcycle are listed in the section entitled "Technical data".

You will find information on more extensive maintenance and repair work in the Repair Manual on DVD for your motorcycle, which is available from your authorised BMW Motorrad dealer.

Some of the work calls for special tools and a thorough knowledge of motorcycle technology. If you are in doubt consult a specialist workshop, preferably your authorised BMW Motorrad dealer.

## Toolkit

### Standard toolkit

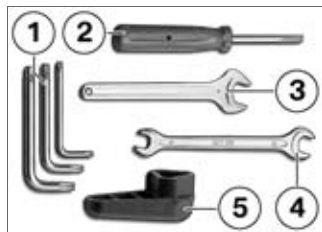

- 1 Torx wrenches T15, T25, T30  
– Removing body panels
- 2 Reversible-blade screwdriver with star-head and plain tips  
– Replacing turn indicator bulbs, front and rear (⇒ 126).
- 3 Open-ended spanner  
Width across flats 14  
– Adjust the mirror arm (⇒ 65).

- 4 Open-ended spanner  
Width across flats 8/10  
– Removing battery (⇒ 136).
- 5 Tool for oil cap  
– Top up the engine oil (⇒ 108).

### Tools for adjusting suspension settings

– without Electronic Suspension Adjustment (ESA)<sup>OE</sup>

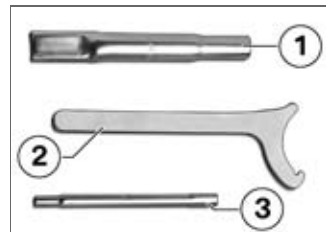

- 1 Extension for hook wrench

- 2 Hook wrench
  - Adjusting spring preload for front wheel (⇒ 66).
- 3 Extension for screwdriver blade
  - Adjusting damping for rear wheel (⇒ 68).

### Tools service set



BMW Motorrad has assembled a tools service set that is ideal for carrying out extended service work (e.g. removing and installing wheels) on this motorcycle. You can obtain the tools set from

your authorised BMW Motorrad dealer.

## Engine oil

### Checking engine oil level

**!** The oil level varies with the temperature of the oil. The higher the temperature, the higher the level of oil in the sump. Checking the oil level with the engine cold or after no more than a short ride will lead to misinterpretation; this in turn, means that the engine will be operated with the incorrect quantity of oil. In order to ensure that the engine oil level is read correctly, check the oil level only after a lengthy trip. ◀

- Switch off the engine when it is at operating temperature.
- Make sure the ground is level and firm and place the motorcycle on its centre stand.

- Wait five minutes for the oil to drain into the oil pan.



- Check the oil level in oil-level indicator 1.

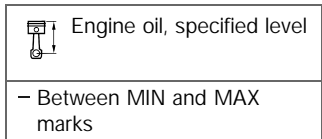
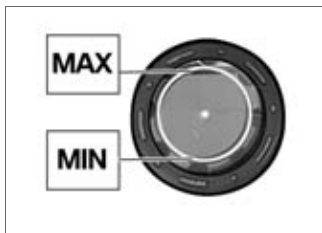

If the oil level is below the MIN mark:

- Top up the engine oil (➔ 108).

If the oil level is above the MAX mark:

- Have the oil level corrected by a specialist workshop, preferably an authorised BMW Motorrad dealer.

## Top up the engine oil

- Make sure the ground is level and firm and place the motorcycle on its stand.



- Wipe the area around the filler neck clean.
- Use the tool from the toolkit to remove cap 1 from the engine-oil filler neck.

 **Damage to the engine** can result if it is operated without enough oil, but the same also applies if the oil level is too high.

Always make sure that the oil level is correct. ◀

- Top up the engine oil to the specified level.

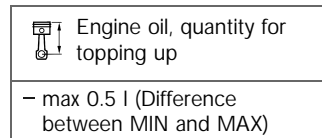

- Checking engine oil level (➔ 107).
- Install the cap of the oil filler neck.

## Brake system

Check operation of the brakes

- Pull the handbrake lever.
  - » The pressure point must be clearly perceptible.
- Press the footbrake lever.
  - » The pressure point must be clearly perceptible.

If pressure points are not clearly perceptible:

 Incorrect working practices endanger the reliability of the brakes.

Have all work on the brake system undertaken by trained and qualified specialists. ◀

- Have the brakes checked by a specialist workshop, preferably an authorised BMW Motorrad dealer.

### Check the front brake pad thickness

- Make sure the ground is level and firm and place the motorcycle on its stand.



- Visually inspect the left and right brake pads to ascertain their thickness. Viewing direction: Between wheel and front suspension toward brake caliper 1.



 Brake-pad wear limit, front

– 1.0 mm (Friction pad only, without backing plate. The wear indicators (grooves) must be clearly visible.)

If the wear indicating marks are no longer clearly visible:

 Brake pads worn past the minimum permissible thickness can cause a reduction in braking efficiency and under certain circumstances they can cause damage to the brake system.

In order to ensure the dependability of the brake system, do not permit the brake pads to wear past the minimum permissible thickness. ◀

- Have the brake pads replaced by a specialist workshop, preferably an authorised BMW Motorrad dealer.

### Checking rear brake pad thickness

- Make sure the ground is level and firm and place the motorcycle on its stand.



- Visually inspect the brake pads to ascertain their thickness. Viewing direction: from the left toward brake caliper 1.

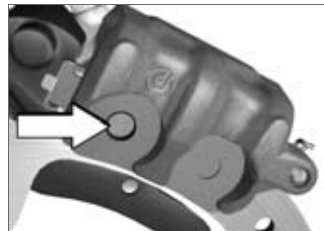

 Brake-pad wear limit, rear

– 1.0 mm (Friction pad only, without backing plate. Make sure that the brake disc is not visible through the bore in the inboard brake block.)

If the brake disc is visible:

 Brake pads worn past the minimum permissible thickness can cause a reduction in braking efficiency and under certain circumstances they can cause damage to the brake system.



In order to ensure the dependability of the brake system, do not permit the brake pads to wear past the minimum permissible thickness. ◀

- Have the brake pads replaced by a specialist workshop, preferably an authorised BMW Motorrad dealer.

### Brake-pad wear

The rear brake has a brake-pad wear indicator.

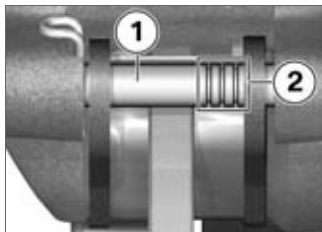

Shaft 1 with three marker rings 2 is between the brake pads.

How to interpret the marks:

- Three rings visible: brake-pad thickness is at least 75 %
- Two rings visible: brake-pad thickness is at least 50 %
- One ring visible: brake-pad thickness is at least 25 %
- No rings visible: brake pads worn to wear limit; check as described above

Check the brake-fluid level, front brakes

 A low fluid level in the brake reservoir can allow air to penetrate the brake system. This significantly reduces braking efficiency.

Check the brake-fluid level at regular intervals. ◀

- Make sure the ground is level and firm and place the motorcycle on its centre stand.
- Move the handlebars to the straight-ahead position.



- Check the brake fluid level in front reservoir 1.

▶ Wear of the brake pads causes the brake fluid level in the reservoir to sink. ◀



Brake fluid level, front

- DOT4 brake fluid
- Do not permit the brake fluid level to drop below the MIN mark. (Brake-fluid reservoir horizontal, motorcycle up-right)

If the brake fluid level drops below the permitted level:

- Have the defect rectified as quickly as possible by a specialist workshop, preferably an authorised BMW Motorrad dealer. ◀

## Replacing screen insert



**⚠** Possible loss of stopping power at front brake.

The screen insert in the front brake-fluid reservoir always has to be replaced on completion of work that affects the level of fluid in the front braking circuit (for example replacing brake pads or changing brake fluid). Consult a specialist workshop, preferably an authorised BMW Motorrad dealer. ◀

## Check the brake-fluid level, rear brakes

 A low fluid level in the brake reservoir can allow air to penetrate the brake system. This significantly reduces braking efficiency.

Check the brake-fluid level at regular intervals. ◀

- Make sure the ground is level and firm and place the motorcycle on its centre stand.

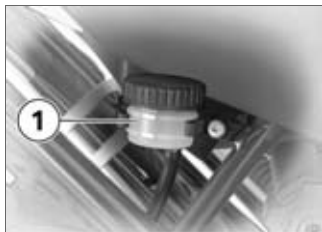

- Check the brake fluid level in rear reservoir 1.

 Wear of the brake pads causes the brake fluid level in the reservoir to sink. ◀



 Brake fluid level, rear

– DOT4 brake fluid

– Do not permit the brake fluid level to drop below the MIN mark. (Brake-fluid reservoir horizontal, motorcycle up-right)

If the brake fluid level drops below the permitted level:

- Have the defect rectified as quickly as possible by a specialist workshop, preferably an authorised BMW Motorrad dealer.

## Clutch

### Checking clutch operation

- Pull the clutch lever.
- » The pressure point must be clearly perceptible.

If the pressure point is not clearly perceptible:

- Have the clutch checked by a specialist workshop, preferably an authorised BMW Motorrad dealer.

### Checking clutch fluid level

- Make sure the ground is level and firm and place the motorcycle on its centre stand.
- Move the handlebars to the straight-ahead position.



- Check the clutch fluid level in reservoir 1.

▶ Wear of the clutch causes the fluid level in the clutch fluid reservoir to rise. ◀



Clutch-fluid level (visual inspection)

- It is impermissible for the clutch fluid level to drop. (Motorcycle upright and handlebars in straight-ahead position)

If the clutch-fluid level drops:

**⚠** Unsuitable hydraulic fluids could cause damage to the clutch system.

Do not attempt to top up the system with fluids of any kind. ◀

- Have the defect rectified as quickly as possible by a specialist workshop, preferably an authorised BMW Motorrad dealer.

## Rims and tyres

### Check the tyre tread depth

**⚠** Your motorcycle's handling and grip can be impaired even before the tyres wear to the minimum tyre tread depth permitted by law.

Have the tyres changed in good time before they wear to the minimum permissible tread depth. ◀

- Make sure the ground is level and firm and place the motorcycle on its stand.
- Measure the tyre tread depth in the main tread grooves with wear marks.

 Tyres have wear indicators integrated into the main tread grooves. The tyre is worn out when the tyre tread has worn down to the level of the marks. The locations of the marks are indicated on the edge of the tyre, e.g. by the letters TI, TWI or by an arrow. ◀

If the tyre tread is worn to minimum:

- Replace tyre or tyres, as applicable.

### Checking rims

- Make sure the ground is level and firm and place the motorcycle on its stand.

- Visually inspect the rims for defects.
- Have damaged rims checked and, if necessary, replaced by a specialist workshop, preferably an authorised BMW Motorrad dealer.

### Checking spokes

- Make sure the ground is level and firm and place the motorcycle on its stand.
- Draw the handle of a screwdriver or a similar instrument across the spokes and listen to the notes of the individual spokes.

If the notes vary:

- Have the spokes checked by a specialist workshop, preferably an authorised BMW Motorrad dealer.

## Wheels

### Tyre recommendation

For each size of tyre BMW Motorrad tests and classifies as roadworthy certain makes. BMW Motorrad cannot assess the suitability or provide any guarantee of road safety for other tyres.

BMW Motorrad recommends using only tyres tested by BMW Motorrad.

You can obtain detailed information from your authorised BMW Motorrad dealer or on the Internet at [www.bmw-motorrad.com](http://www.bmw-motorrad.com).

### Effect of wheel size on suspension-control systems

Wheel size is very important as a parameter for the suspension-control systems ABS and ASC. In particular, the diameter and the width of a motorcycle's wheels

are programmed into the control unit and are fundamental to all calculations. Any change in these influencing variables, caused for example by a switch to wheels other than those installed ex-works, can have serious effects on the performance of the control systems.

The sensor rings are essential for correct road-speed calculation, and they too must match the motorcycle's control systems and consequently cannot be changed.

If you decide that you would like to fit non-standard wheels to your motorcycle, it is very important to consult a specialist workshop beforehand, preferably an authorised BMW Motorrad dealer. In some cases, the data programmed into the control units can be changed to suit the new wheel sizes.

## RDC label

- with tyre pressure monitoring (RDC)<sup>OE</sup>



 Incorrect tyre-removal procedures can result in damage to the RDC sensors. Be sure to notify the authorised BMW Motorrad dealer or specialist workshop that the wheel is fitted with an RDC sensor. ◀

If the motorcycle is equipped with RDC, each wheel rim bears an adhesive label indicating the position of the RDC sensor. When changing the tyre, take

care not to damage the RDC sensor. Be sure to draw the attention of the authorised BMW Motorrad dealer or specialist workshop to the fact that the wheel is fitted with an RDC sensor.

## Remove the front wheel

- Make sure the ground is level and firm and place the motorcycle on its centre stand.
- with BMW Motorrad Integral ABS II<sup>OE</sup>



- Unclip the two retaining clips 1 holding the ABS sensor cable to the brake line. ◀

- Mask off the parts of the wheel rim that could be scratched in the process of removing the brake calipers.

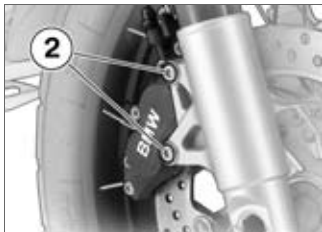

**⚠** Once the calipers have been removed, there is a risk of the brake pads being pressed together to the extent that they cannot be slipped back over the brake disc on reassembly.

Do not operate the handbrake lever when the brake calipers have been removed. ◀

- Remove securing screws 2 of the left and right brake calipers.



- Force the brake pads 3 slightly apart by rocking brake caliper 4 back and forth against brake disc 5.
- Carefully pull the brake calipers back and out until clear of the brake discs.

- with BMW Motorrad Integral ABS II<sup>OE</sup>



- Remove screw 1 and remove the ABS sensor from its bore. ◁
- Raise front of motorcycle until the front wheel can turn freely. BMW Motorrad recommends the BMW Motorrad front-wheel stand for lifting the motorcycle.
- Install the front-wheel stand (➔ 121).

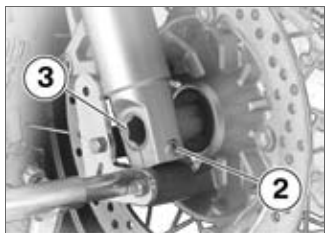

- Release axle clamping screw 2.
- Remove quick-release axle 3, while supporting the wheel.
- Roll the front wheel forward to remove.



- Remove spacing bushing 4 from the front-wheel hub.

### Installing front wheel

**⚠** Possible malfunctions when ABS and ASC systems intervene if non-standard wheels are installed.

See the information on the effect of wheel size on the ABS and ASC systems at the start of this chapter. ◀

**⚠** Threaded fasteners not tightened to the specified torque can work loose or their threads can suffer damage.

Always have the security of the fasteners checked by a specialist workshop, preferably an authorised BMW Motorrad dealer. ◀



- Install spacing bushing 4 in the wheel hub.

**⚠** The front wheel must be installed right way round to rotate in the correct direction. Note the direction-of-rotation arrows on the tyre or the wheel rim. ◀

- Roll the front wheel into position between the front forks.



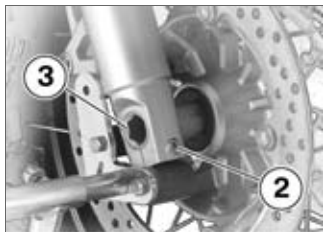

- Raise the front wheel, insert quick-release axle 3 and tighten to specified torque.

 Quick-release axle in axle holder

– 50 Nm

- Tighten axle clamping screw 2 to the specified torque.

 Clamp screw of quick-release axle

– 19 Nm

– with BMW Motorrad Integral ABS II<sup>OE</sup>



- Insert the ABS sensor into its bore and install screw 1. ◁
- Remove the front-wheel stand.
- Ease the brake calipers on to the brake discs.

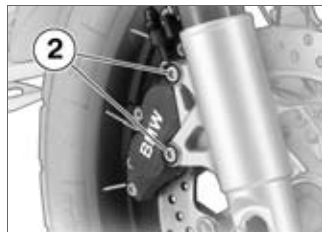

- Install securing screws 2 on left and right and tighten to specified tightening torque.

 Brake caliper to slider tube

– 30 Nm

- Remove the adhesive tape from the wheel rim.

 Braking efficiency is impaired if the brake pads are not correctly bedded against the discs.

Before riding off, always check that the brakes bite as soon as

the brake lever is pulled or the brake pedal depressed.◀

- Operate the brake several times until the brake pads are bedded.

– with BMW Motorrad Integral ABS II<sup>OE</sup>



- Clip on retaining clips 1 holding the sensor cable to the brake line.
- Check that the sensor cable is held securely at clip 3; if necessary clip the cable into the clip.

 The cable of the wheel-speed sensor could chafe through if it comes into contact with the brake disc. Make sure that the sensor cable is routed correctly.◀

- Make sure that the sensor cable is routed as shown here.◀

Remove the rear wheel

- Make sure the ground is level and firm and place the motorcycle on its centre stand.
- Engage first gear.



 Parts of the exhaust system can be hot.

Do not touch hot parts of the exhaust system.◀

- Remove studs 1 from the rear wheel, while supporting the wheel.
- Lower the rear wheel to the ground and roll it out to the rear.

Installing rear wheel

 Possible malfunctions when ABS and ASC systems intervene if non-standard wheels are installed.

See the information on the effect of wheel size on the ABS and ASC systems at the start of this chapter. ◀

 Threaded fasteners not tightened to the specified torque can work loose or their threads can suffer damage.

Always have the security of the fasteners checked by a specialist workshop, preferably an authorised BMW Motorrad dealer. ◀

- Seat the rear wheel on the rear-wheel adapter.

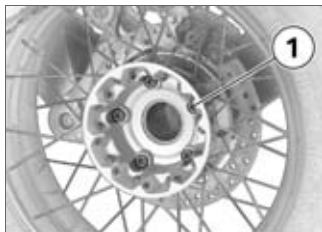

- Install wheel studs 1 and tighten to specified torque.



Rear wheel to wheel carrier

– Tightening sequence: tighten in diagonally opposite sequence

– 60 Nm

## Front-wheel stand

### Install the front-wheel stand

 The BMW Motorrad front wheel stand is not designed to support motorcycles not fitted with a centre stand or without other auxiliary stands. A motorcycle resting only on the front wheel stand and the rear wheel can topple.

Place the motorcycle on its centre stand or another auxiliary stand before lifting the front wheel with the BMW Motorrad front-wheel stand. ◀

- Make sure the ground is level and firm and place the motorcycle on its centre stand.
- Use basic stand (0 402 241) with front-wheel adapter (0 402 242).

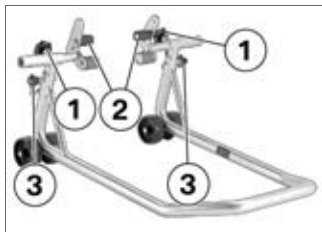

- Slacken adjusting screws 1.
- Push the two adapters 2 apart until the front forks fit between them.
- Use locating pins 3 to set the front-wheel stand to the desired height.
- Centre the front-wheel stand relative to the front wheel and push it against the front axle.

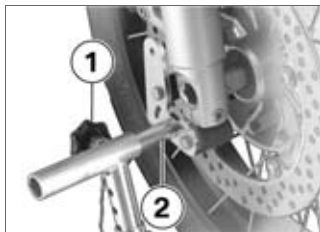

- Align the two adapters 2 so that the front forks are securely seated.
- Tighten adjusting screws 1.



**!** If the motorcycle is on the centre stand and is raised too far, the centre stand will lift clear of the ground and the motorcycle could topple to one side. When raising the motorcycle, make sure that the centre stand remains on the ground. ◀

- Apply uniform pressure to push the front-wheel stand down and raise the motorcycle.

# Bulbs

## General instructions

A warning appears in the multi-function display if a bulb is defective. If the brake or rear light fails, the symbol is accompanied by the 'General' warning light, which lights up yellow.

**!** A defective bulb places your safety at risk because it is easier for other users to oversee the motorcycle. Replace defective bulbs as soon as possible; always carry a complete set of spare bulbs if possible. ◀

**!** The bulb is pressurised and can cause injury if damaged. Wear protective goggles and gloves when changing bulbs. ◀

▷ The types of bulb fitted to your motorcycle are listed

in the section entitled "Technical data". ◀

## Replacing low-beam/high-beam headlight bulb

▷ The positions of the plug, the spring retainer and the bulb might not be as illustrated below. ◀

- Make sure the ground is level and firm and place the motorcycle on its stand.
- Switch off the ignition.

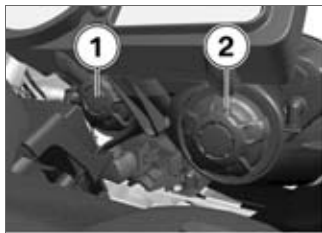

- Remove high-beam headlight cover 1 or low-beam headlight

cover 2 by turning the cover counter-clockwise.



- Disconnect plug 3.

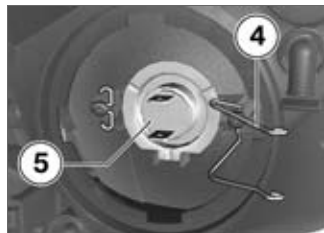

- Disengage spring clip 4 and swing it aside.
- Remove bulb 5.

- Replace the defective bulb.

▶ Do not touch the glass of new bulbs with your fingers. Use a clean, dry cloth to hold the bulbs when handling them. Dirt deposits, in particular oil and grease, interfere with heat radiation from the bulb. This leads to overheating and shortens the bulb's operating life.◀



Bulbs for the low-beam headlight

– H7 / 12 V / 55 W



Bulb for high-beam headlight

– H7 / 12 V / 55 W



- Install bulb 5, making sure that tab 6 is correctly positioned.

▶ The bulb might face in a direction other than that shown here.◀

- Engage spring clip 4 in the catch.



- Install plug 3.

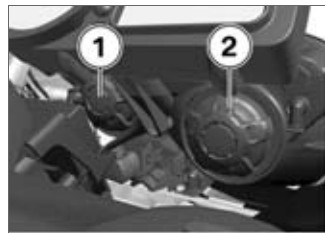

- Fit high-beam headlight cover 1 or low-beam headlight cover 2 by turning the cover clockwise. Make sure that the wording TOP is at the top.

## Replacing parking-light bulb

- Make sure the ground is level and firm and place the motorcycle on its stand.
- Switch off the ignition.
- Turn the handlebars all the way to the right



- Pull bulb carrier 1 out of the headlight housing.



- Pull the bulb out of the bulb socket.
- Replace the defective bulb.

▶ Do not touch the glass of new bulbs with your fingers. Use a clean, dry cloth to hold the bulbs when handling them. Dirt deposits, in particular oil and grease, interfere with heat radiation from the bulb. This leads to overheating and shortens the bulb's operating life.◀



Bulb for parking light

– W5W / 12 V / 5 W



- Install the bulb in the bulb socket.



- Install bulb carrier 1 in the headlight housing.

### Replacing turn indicator bulbs, front and rear

- Make sure the ground is level and firm and place the motorcycle on its stand.



- Remove screw 1.



- Pull the glass out of the reflector housing at the threaded-fastener side.

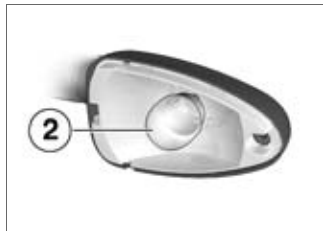

- Turn bulb 2 counter-clockwise and remove it from the bulb housing.
- Replace the defective bulb.

▶ Do not touch the glass of new bulbs with your fingers. Use a clean, dry cloth to hold the bulbs when handling them. Dirt deposits, in particular oil and grease, interfere with heat radiation from the bulb. This leads to overheating and shortens the bulb's operating life. ◀





Bulbs for flashing turn indicators, front

– RY10W / 12 V / 10 W

– with LED turn indicators<sup>OE</sup>

– LED / 12 V◁



Bulbs for flashing turn indicators, rear

– RY10W / 12 V / 10 W

– with LED turn indicators<sup>OE</sup>

– LED / 12 V◁

2



- Turn bulb 2 clockwise to install it in the bulb housing.



- Working from the inboard side, insert the glass into the bulb housing and close the housing.



- Install screw 1.

## Replacing auxiliary-headlight bulbs

– with auxiliary headlights<sup>OE</sup>



The procedure described below applies only to auxiliary headlights with halogen bulbs. The LED auxiliary headlights can only be replaced as complete units.◀

- Make sure the ground is level and firm and place the motorcycle on its stand.



- Disconnect plug 1.
- Slacken screw 2.

- Pivot the headlight lens forward.



- Remove four screws 3.
- Push bulb cover 4 down to remove.



- Pull bulb housing 5 down until it is clear of the holder.



- Turn bulb 6 counter-clockwise to remove.

- Replace the defective bulb.



Bulb for auxiliary headlight

– H11 / 12 V / 55 W

– with LED auxiliary headlights<sup>OA</sup>

– LED / 12 V<



- Insert bulb 6 into its socket and turn it clockwise to install.



- Push bulb housing 5 up into the holder from below.



- Seat bulb cover 4 from below.
- Install four screws 3.
- Pivot the headlight lens back.



- Tighten screw 2.
- Connect plug 1.
- Adjust the headlight so that it does not dazzle oncoming traffic.

Replacing fuses for auxiliary headlights  
– with auxiliary headlights<sup>OE</sup>



- Pull off side cover 1.

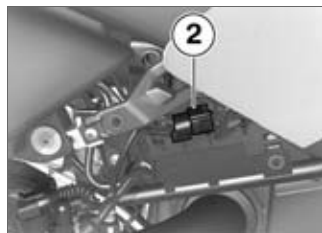

- Disconnect plug 2.



- To do so, squeeze retaining clips 3 together on left and right and disconnect the plug.

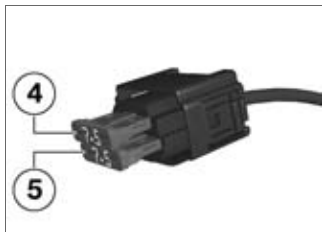

- Replace fuse 4 for right headlight or fuse 5 for left headlight, as applicable.



Fuse for auxiliary headlight

- with auxiliary headlights<sup>OE</sup> or
- with LED auxiliary headlights<sup>OA</sup>
- 7.5 A<

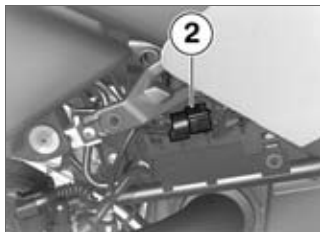

- Connect plug 2.



- Install side cover 1.

## Air filter

Remove the air filter

- Make sure the ground is level and firm and place the motorcycle on its stand.
- Remove the front seat (→ 72).



- Remove long screw 1 and short screws 2 and remove the cover.

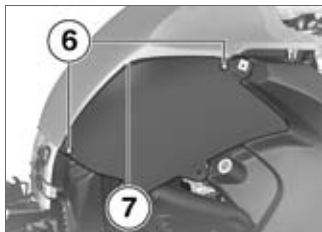

- Remove two screws 6 and pull the fuel-tank cover out of holder 7.



- Pull out air filter 3 at the bottom.

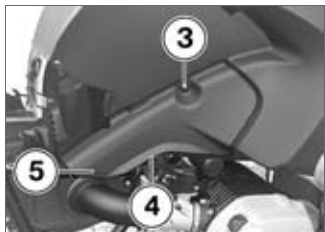

- Remove screw 3.
- Pull the side cover at 4 and 5 to disengage it from the holders.



- Push out both retainers 1 by pressing at rear.
- Pull the intake air pipe out of holder 2 and remove.

### Installing air filter



- Insert air filter 3 into the air filter housing at the top.

- Push the air filter into the air filter housing at the bottom, making sure that the vanes are not bent.



- Position the air intake pipe on the air filter housing and push it into holder 2.
- Push retainers 1 into the holders until they engage with an audible click.



 **Cylinders not synchronised.** Make sure the throttle-valve cable is correctly routed. ◀

- Check that the throttle-valve cable is seated in guide 4 of the intake and that the throttle valve is seated against the stop.

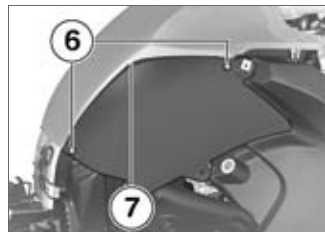

- Seat the fuel-tank cover in holder 7 and install two screws 6.

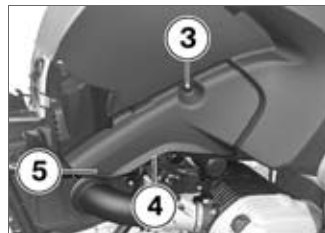

- Press the side cover at 4 and 5 to engage it in the holders.
- Install screw 3.



- Hold the cover in position and install short screws 2 and long screw 1.
- Install the front seat (⇒ 73).

## Jump starting

**⚠** The wires leading to the power socket do not have a load-capacity rating adequate for jump-starting the engine. Excessively high current can lead to a cable fire or damage to the vehicle electronics. Do not use the on-board socket to jump-start the engine of the motorcycle. ◀

**⚠** A short-circuit can result if the crocodile clips of the jump leads are accidentally brought into contact with the motorcycle.

Use only jump leads fitted with fully insulated crocodile clips at both ends. ◀

**⚠** Jump-starting with a donor battery voltage higher than 12 V can damage the vehicle electronics.

Make sure that the battery of the donor vehicle has a voltage rating of 12 V. ◀

- Make sure the ground is level and firm and place the motorcycle on its stand.
- Remove the front seat (⇒ 72).
- When jump-starting the engine, do not disconnect the battery from the on-board electrical system.



- Remove protective cap 1 from the battery's positive terminal.
- Begin by connecting one end of the red jump lead to the positive terminal of the discharged battery and the other end to the positive terminal of the donor battery (positive on this vehicle: position 2).
- Then connect one end of the black jump lead to the negative terminal of the donor battery and the other end to the negative terminal of the discharged battery (negative on this vehicle: position 3).

 The spring-strut screw can be used as an alternative to the battery's negative terminal. ◀

- Run the engine of the donor vehicle during jump-starting.
- Start the engine of the vehicle with the discharged battery in the usual way; if the engine does not start, wait a few minutes before repeating the attempt in order to protect the starter motor and the donor battery.
- Allow both engines to idle for a few minutes before disconnecting the jump leads.
- Disconnect the jump lead from the negative terminals first, then disconnect the second lead from the positive terminals.
- Remember to reinstall the protective cap on the battery's positive terminal.

 Do not use proprietary start-assist sprays or other products to start the engine. ◀

- Install the front seat (→ 73).

## Battery

### Maintenance instructions

Correct upkeep, recharging and storage will prolong the life of the battery and are essential if warranty claims are to be considered.

Compliance with the points below is important in order to maximise battery life:

- Keep the surface of the battery clean and dry
- Do not open the battery
- Do not top up with water
- Be sure to read and comply with the instructions for charging the battery on the following pages
- Do not turn the battery upside down



If the battery is not disconnected, the on-board electronics (e.g. clock, etc.) gradually drain the battery. This can cause the battery to run flat. If this happens, warranty claims will not be accepted.

If the motorcycle is to be out of use for more than four weeks, disconnect the battery or connect a suitable trickle charger to the battery. ◀



BMW Motorrad has developed a float charger specially designed for compatibility with the electronics of your motorcycle. Using this charger, you can keep the battery charged during long periods of disuse, without having to disconnect the battery from the motorcycle's on-board systems. You can obtain additional information from your authorised BMW Motorrad dealer. ◀



## Charge the battery when connected

 Charging the connected battery directly at the battery terminals can damage the vehicle electronics.

Always disconnect the battery from the on-board circuits before recharging it with a charger connected directly to the battery posts. ◀

 If you switch on the ignition and the multifunction display and telltale lights fail to light up, the battery is completely flat. Attempting to charge a completely flat battery via the on-board socket can cause damage to the motorcycle's electronics. If a battery has discharged to the extent that it is completely flat, it has to be disconnected from the on-board circuits and charged with the charger connected directly to the battery posts. ◀

 Only chargers suitable for this mode of charging can be used to recharge the battery via the on-board socket. Unsuitable chargers could cause damage to the motorcycle's on-board electrics.

Use BMW chargers with the part numbers 71 60 7 688 864 (220 V) or, as applicable, 71 60 7 688 865 (110 V). If you are in doubt, disconnect the battery from the on-board systems and connect the charger directly to the battery. ◀

- Charge via the power socket, with the battery connected to the motorcycle's on-board electrical system.

 The motorcycle's on-board electronics know when the battery is fully charged. The on-board socket is switched off when this happens. ◀

- Comply with the operating instructions of the charger.

 If you are unable to charge the battery through the on-board socket, you may be using a charger that is not compatible with your motorcycle's electronics. If this happens, disconnect the battery from the on-board systems and connect the charger directly to the battery. ◀◀

## Charging battery when disconnected

- Charge the battery using a suitable charger.
- Comply with the operating instructions of the charger.
- Once the battery is fully charged, disconnect the charger's terminal clips from the battery terminals.

 The battery has to be recharged at regular intervals in the course of a lengthy period

of disuse. See the instructions for caring for your battery. Always fully recharge the battery before restoring it to use ◀

### Removing battery

- Remove the front seat (→ 72).
- Remove the rider's manual, if applicable.



- Remove screw 1 and remove the holder.
- with anti-theft alarm (DWA)<sup>OE</sup>
- If applicable, switch off the anti-theft alarm. ◀

- Switch off the ignition.

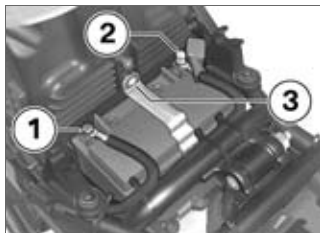

**!** Disconnection in the wrong sequence increases the risk of short-circuits. Always proceed in the correct sequence. ◀

- Disconnect negative battery lead 1 first.
- Then remove the protective cap and disconnect positive lead 2.
- Remove screw 3 of the battery retainer.
- Disengage the retainer at the bottom and remove.

- Lift the battery up and out; work it slightly back and forth if it is difficult to remove.

### Installing battery

- Place the battery in the battery compartment, positive terminal on the right in the forward direction of travel.
- Engage the retainer at the bottom and push it over the battery.

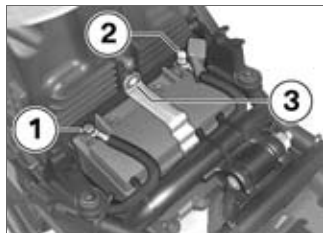

- Install screw 3 of the battery retainer.

 Installation in the wrong sequence increases the risk of short-circuits.

Always proceed in the correct sequence.

Never install the battery without the protective cap. ◀

- Connect battery positive lead 2 first.
- Connect battery negative lead 1.
- Switch on the ignition.

 If the battery was disconnected from the motorcycle for a prolonged period of time it will be necessary to enter the current date in the instrument panel, in order to ensure that the service-due indicator functions correctly.

If you want to have the date set consult a specialist workshop, preferably an authorised BMW Motorrad dealer. ◀

- Fully open the throttle once or twice.
  - » The engine management system registers the throttle-valve positions.



- Hold the holder in position and install screw 1.
- Insert the rider's manual, if applicable.
- Install the front seat (➔ 73).
- Setting clock (➔ 48).



Care	
Care products .....	140
Washing motorcycle .....	140
Cleaning easily damaged components.....	140
Paint care .....	141
Protective wax coating .....	142
Laying up motorcycle .....	142
Restoring motorcycle to use .....	142

## Care products

BMW Motorrad recommends that you use the cleaning and care products you can obtain from your authorised BMW Motorrad dealer. The substances in BMW CareProducts have been tested in laboratories and in practice; they provide optimised care and protection for the materials used in your vehicle.

 The use of unsuitable cleaning and care products can damage vehicle components. Do not use solvents such as cellulose thinners, cold cleaners, fuel or the like, and do not use cleaning products that contain alcohol. ◀

## Washing motorcycle

BMW Motorrad recommends that you use BMW insect remover to soften and wash off insects and stubborn dirt on

painted parts prior to washing the motorcycle.

To prevent stains, do not wash the motorcycle immediately after it has been exposed to strong sunlight and do not wash it in the sun.

Make sure that the motorcycle is washed frequently, especially during the winter months.

To remove road salt, clean the motorcycle with cold water immediately after every trip.

 After the motorcycle has been washed, ridden through water or ridden in the rain, the brake discs and pads might be wet and the brakes might not take effect immediately.

Apply the brakes in good time until the brake discs and brake pads have dried out. ◀

 Warm water intensifies the effect of salt.

Use only cold water to wash off road salt. ◀

 The high pressure of steam cleaners can damage seals, the hydraulic brake system, the electrical system, and the seat. Do not use a steam jet or high-pressure cleaning equipment. ◀

## Cleaning easily damaged components

### Body panels

Clean the trim panels with water and BMW plastic care emulsion.

 If plastic parts are cleaned using unsuitable cleaning agents, the surfaces can be damaged.

Do not use cleaning agents that contain alcohol, solvents or abrasives to clean plastic parts.

Even fly-remover pads or cleaning pads with hard surfaces can produce scratches. ◀

 Soften stubborn dirt and insects by covering the affected areas with a wet cloth. ◀

## Windscreen and headlight lens plastic

Clean off dirt and insects with a soft sponge and plenty of water.

 Fuel and chemical solvents attack the material of the windscreen; the windscreen becomes opaque or dull.

Do not use cleaning agents. ◀

## Chrome

Use plenty of water and BMW shampoo to clean chrome, particularly if it has been exposed to road salt. Use chrome polish for additional treatment.

## Radiator

Clean the radiator regularly to prevent overheating of the engine due to inadequate cooling. For example, use a garden hose with low water pressure.

 Cooling fins can be bent easily.

Take care not to bend the fins when cleaning the radiator. ◀

## Rubber

Treat rubber components with water or BMW rubber-care products.

 Using silicone sprays for the care of rubber seals can cause damage.

Do not use silicone sprays or other care products that contain silicon. ◀

## Paint care

Washing the motorcycle regularly will help counteract the long-term effects of substances that damage the paint, especially if your motorcycle is ridden in areas with high air pollution or natural sources of dirt, for example tree resin or pollen.

Remove particularly aggressive substances immediately, however, as otherwise the paint can be affected or become discoloured. Substances of this nature include spilt fuel, oil, grease, brake fluid and bird droppings. We recommend BMW vehicle polish or BMW paint cleaner for this purpose.

Marks on the paintwork are particularly easy to see after the motorcycle has been washed. Remove stains of this kind immediately, using cleaning-grade benzene or petroleum spirit on a clean cloth or ball of cotton wool.

BMW Motorrad recommends BMW tar remover for removing specks of tar. Remember to wax the parts treated in this way.

## Protective wax coating

BMW Motorrad recommends applying only BMW car wax or products containing carnauba wax or synthetic wax.

It is time to re wax the paint-work when water "puddles" on the surface, instead of forming beads.

## Laying up motorcycle

- Clean the motorcycle.
- Removing battery (➔ 136).
- Spray the brake and clutch lever pivots and the main and side stand pivots with a suitable lubricant.
- Coat bright metal and chrome-plated parts with an acid-free grease (e.g. Vaseline).

- Stand the motorcycle in a dry room in such a way that there is no load on either wheel. Authorised BMW Motorrad dealers can provide suitable auxiliary stands.

▷ Before laying the vehicle up out of use, have the engine oil and the oil filter element changed by a specialist workshop, preferably an authorised BMW Motorrad dealer. Combine work for laying up/restoring to use with a BMW service or inspection.◀

## Restoring motorcycle to use

- Remove the protective wax coating.
- Clean the motorcycle.
- Install a charged battery.
- Before starting: work through the checklist.



Technical data			
Troubleshooting chart .....	144	Riding specifications .....	157
Threaded fasteners .....	145		
Engine .....	147		
Fuel .....	148		
Engine oil .....	149		
Clutch .....	150		
Transmission .....	150		
Rear-wheel drive .....	151		
Running gear .....	151		
Brakes .....	152		
Wheels and tyres .....	153		
Electrics .....	154		
Frame .....	156		
Dimensions .....	156		
Weights .....	157		

## Troubleshooting chart

Engine does not start or is difficult to start

Possible cause	Remedy
Emergency off switch (kill switch)	Kill switch in operating position
Side stand	Retract the side stand. (➔ 78)
Gear engaged and clutch not disengaged	Select neutral or pull clutch lever (➔ 78)
Clutch pulled before ignition was switched on	Switch on the ignition, then pull the clutch lever
No fuel in tank	Refuelling (➔ 85).
Battery flat	Charge the battery when connected (➔ 135).

## Threaded fasteners

Front wheel	Value	Valid
Brake caliper to slider tube		
M8 x 32 - 10.9	30 Nm	
Clamp screw of quick-release axle		
M8 x 35	19 Nm	
Quick-release axle in axle holder		
M24 x 1.5	50 Nm	
Rear wheel	Value	Valid
Rear wheel to wheel carrier		
M10 x 53 x 1.25	tighten in diagonally opposite sequence	
	60 Nm	
Mirror arm	Value	Valid
Mirror to adapter		
Locknut, M10 x 1.25 - 4.8	22 Nm	

Mirror arm	Value	Valid
Mirror adapter to clamping block		
M10 x 14 - 4.8	25 Nm	
Shift lever	Value	Valid
Peg to gearshift lever		
M6 x 16	8 Nm	

## Engine

Engine design	Four-stroke opposed twin, air-cooled with oil-cooled exhaust ports, installed longitudinally, two overhead camshafts and four radially positioned valves per cylinder, electronic engine management.
Displacement	1170 cm <sup>3</sup>
Cylinder bore	101 mm
Piston stroke	73 mm
Compression ratio	12.0 : 1
Nominal output	81 kW, at engine speed: 7750 min <sup>-1</sup>
– with power reduction <sup>OE</sup>	72 kW, at engine speed: 7750 min <sup>-1</sup>
Torque	120 Nm, at engine speed: 6000 min <sup>-1</sup>
– with power reduction <sup>OE</sup>	120 Nm, at engine speed: 6000 min <sup>-1</sup>
Maximum engine speed	max 8500 min <sup>-1</sup>
Idle speed	1150±50 min <sup>-1</sup> , Engine at regular operating temperature

## Fuel

Recommended fuel grade	Premium plus unleaded 98 ROZ/RON 91 AKI
alternative fuel grade	Premium unleaded (slight power- and consumption-related restrictions) 95 ROZ/RON 89 AKI
- with regular unleaded (RON 91) <sup>OE</sup>	Regular unleaded (power- and consumption-re- lated restrictions) 91 ROZ/RON 87 AKI
Usable fuel capacity	approx. 33 l
Reserve fuel	approx. 4 l

BMW recommends 

## Engine oil

Engine oil, capacity	max 4.0 l, with filter change
of products recommended by BMW Motorrad and generally admissible viscosity classes	
Castrol GPS SAE 10W-40, API SG / JASO MA	$\geq -20$ °C
SAE 5W-40, API SF / ACEA A2, or better	$\geq -20$ °C
SAE 5W- $\geq$ 50, API SF / ACEA A2, or better	$\geq -20$ °C
SAE 10W-40, API SF / ACEA A2, or better	$\geq -10$ °C
SAE 10W- $\geq$ 50, API SF / ACEA A2, or better	$\geq -20$ °C
SAE 15W- $\geq$ 40, API SF / ACEA A2, or better	$\geq 0$ °C
Engine oil, quantity for topping up	max 0.5 l, Difference between MIN and MAX

BMW recommends 

## Clutch

Clutch type	Single-plate dry clutch
-------------	-------------------------

## Transmission

Gearbox type	Helical 6-speed gearbox with integral reaction damper, claw-action shift by sliding sleeves
Gearbox transmission ratios	1,737, Primary transmission ratio 2.375 (38:16 teeth), 1st gear 1.696 (39:23 teeth), 2nd gear 1.296 (35:27 teeth), 3rd gear 1.065 (33:31 teeth), 4th gear 0.939 (31:33 teeth), 5th gear 0.848 (28:33 teeth), 6th gear
- with Enduro gearbox <sup>OE</sup>	1,737, Primary transmission ratio 2.600 (39:15 teeth), 1st gear 1.696 (39:23 teeth), 2nd gear 1.296 (35:27 teeth), 3rd gear 1.065 (33:31 teeth), 4th gear 0.939 (31:33 teeth), 5th gear 0.848 (28:33 teeth), 6th gear



## Rear-wheel drive

Type of final drive	Shaft drive with bevel gears
Type of rear suspension	Cast-aluminium single swinging arm with BMW Motorrad Paralever
Gear ratio of final drive	2.910 (32:11 teeth)

## Running gear

Front wheel	
Type of front suspension	BMW Telelever, with anti-dive top fork bridge, leading link pivot-mounted on engine and telescopic forks, central spring strut supported by leading link and front frame
Spring strut, front, type	Central spring strut with coil spring and twin-tube gas-filled shock absorber; spring preload mechanically adjustable
– with Electronic Suspension Adjustment (ESA) <sup>OE</sup>	Central spring strut with single-tube gas-filled shock absorber, electrically adjustable rebound damping and electro-hydraulically adjustable spring preload
Spring travel, front	210 mm, At wheel

Rear wheel	
Type of rear suspension	Cast-aluminium single swinging arm with BMW Motorrad Paralever
Type of rear suspension	Central spring strut with coil spring, adjustable rebound damping and hydraulically adjustable spring preload
– with Electronic Suspension Adjustment (ESA) <sup>OE</sup>	Central spring strut with coil spring, electrically adjustable rebound damping and electro-hydraulically adjustable spring preload
Spring travel at rear wheel	220 mm

## Brakes

Type of front brake	Hydraulically operated twin disc brake with 4-piston fixed calipers and floating brake discs
Brake-pad material, front	Sintered metal
Type of rear brake	Hydraulically operated disc brake with 2-piston floating caliper and fixed disc
Brake-pad material, rear	Organic material
– with BMW Motorrad Integral ABS II <sup>OE</sup>	Sintered metal

## Wheels and tyres

Recommended tyre sets	You can obtain an up-to-date list of approved tyres from your authorised BMW Motorrad dealer or on the Internet at " <a href="http://www.bmw-motorrad.com">www.bmw-motorrad.com</a> ".
Front wheel	
Front wheel, type	Cross-spoked wheel with 40 spokes, MT H2
Front wheel rim size	2.50" x 19"
Tyre designation, front	110 / 80 - 19
Rear wheel	
Rear wheel type	Cross-spoked wheel with 40 spokes, MT H2
Rear wheel rim size	4.00" x 17"
Tyre designation, rear	150 / 70 - 17
Tyre pressures	
Tyre pressure, front	2.2 bar, one-up, tyre cold 2.5 bar, two-up and/or with luggage, tyre cold
Tyre pressure, rear	2.5 bar, one-up, tyre cold 2.9 bar, two-up and/or with luggage, tyre cold

## Electrics

Electrical rating of on-board socket	5 A
– with extra socket <sup>OA</sup>	max 5 A, Total for all sockets
Fuses	Electronic fuses protect the circuits. If an electronic fuse trips and de-energises a circuit, the circuit is active as soon as the ignition is switched on after the fault has been rectified.
Fuse for auxiliary headlight	
– with auxiliary headlights <sup>OE</sup> or – with LED auxiliary headlights <sup>OA</sup>	7.5 A
Battery	
Battery type	AGM (Absorbent Glass Mat) battery
Battery rated voltage	12 V
Battery rated capacity	14 Ah
Spark plugs	
Spark plugs, manufacturer and designation	NGK MAR8B-JDS
Electrode gap of spark plug	0.8±0.1 mm

Lighting	
Bulb for high-beam headlight	H7 / 12 V / 55 W
Bulbs for the low-beam headlight	H7 / 12 V / 55 W
Bulb for parking light	W5W / 12 V / 5 W
Bulb for tail light/brake light	LED / 12 V
Bulbs for flashing turn indicators, front	RY10W / 12 V / 10 W
– with LED turn indicators <sup>OE</sup>	LED / 12 V
Bulbs for flashing turn indicators, rear	RY10W / 12 V / 10 W
– with LED turn indicators <sup>OE</sup>	LED / 12 V
Bulb for auxiliary headlight	
– with auxiliary headlights <sup>OE</sup>	H11 / 12 V / 55 W
– with LED auxiliary headlights <sup>OA</sup>	LED / 12 V

## Frame

Frame type	Tubular steel front frame and rear frame, with load-bearing drive unit
Type plate location	On left side behind side cover
VIN location	Front frame top centre

## Dimensions

Length of motorcycle	2240 mm, Across luggage carrier
Height of motorcycle	1525 mm, Over windscreen, at DIN unladen weight
Width of motorcycle	980 mm, Across handlebars
Front-seat height	890...910 mm, At unladen weight

## Weights

Unladen weight	256 kg, DIN unladen weight, ready for road 90 % load of fuel, without optional extras
Permissible gross weight	475 kg
Maximum payload	219 kg

## Riding specifications

Top speed	>200 km/h
-----------	-----------





## Service

BMW Motorrad service .....	160
BMW Motorrad service quality .....	160
BMW Motorrad mobility services - roadside assistance .....	160
BMW Motorrad service network .....	161
Maintenance work .....	161
Confirmation of maintenance work .....	162
Confirmation of service .....	167

## BMW Motorrad service

Advanced technology requires specially adapted methods of maintenance and repair.



If maintenance and repair work is performed inexpertly, it could result in consequential damage and thus constitute a safety risk.

BMW Motorrad recommends you to have all the associated work on your motorcycle carried out by a specialist workshop, preferably an authorised BMW Motorrad dealer. ◀

Your authorised BMW Motorrad dealer can provide information on BMW services and the work undertaken as part of each service. Have all maintenance and repair work carried out confirmed in the "Service" chapter in this manual. Authorised BMW Motorrad dealers are supplied with the latest technical information and have

the necessary technical know-how. BMW Motorrad recommends that you contact your authorised BMW Motorrad dealer if you have questions regarding your motorcycle.

## BMW Motorrad service quality

Along with its reputation for engineering quality and high reliability, BMW Motorrad is a byword for excellent quality of service.

To ensure that your BMW is always in optimum condition, BMW Motorrad recommends that you have the maintenance work required for your motorcycle carried out regularly, preferably by your authorised BMW Motorrad dealer. For generous treatment of claims submitted after the warranty period has expired, evidence of regular maintenance is essential.

Certain signs of wear, moreover, may otherwise not be noticed until it is too late to put them right at moderate cost. Your authorised BMW Motorrad dealer's mechanics know every detail of your motorcycle and can take remedial action if necessary before minor faults develop into serious problems. By having the necessary repairs done properly and in good time, you save time and money in the long run.

## BMW Motorrad mobility services - roadside assistance

In the event of a breakdown, the BMW Motorrad mobility services available for each new BMW motorcycle enable you to access an extensive range of services such as breakdown assistance, motorcycle transportation etc. (details can differ from country to country). In the event of a breakdown,

contact the Mobile Service organisation of BMW Motorrad. The specialists will provide the necessary advice and assistance. You will find important country-specific contact addresses and the after-sales service organisation phone numbers in the "Service Kontakt / Service Contact" brochures, along with information on Mobile Service and the dealership network.

## BMW Motorrad service network

BMW Motorrad has an extensive after-sales service network in place to look after you and your motorcycle in more than 100 countries. In Germany alone, you have the best possible access to approximately 200 authorised BMW Motorrad dealers.

All information concerning the international dealership network can be found in the brochure

"Service Contact Europe" or "Service Contact Africa, America, Asia, Australia, Oceania".

## Maintenance work

### BMW Pre-delivery Check

Your authorised BMW Motorrad dealer conducts the BMW pre-delivery check before handing over the motorcycle to you.

### BMW Running-in Check

The BMW running-in check has to be performed when the motorcycle has covered between 500 km and 1,200 km

### BMW Service

The BMW Service is carried out once a year; the extent of servicing can vary, depending on the age of the motorcycle and the distance it has covered. Your authorised BMW Motorrad dealer confirms that the service work has been carried out and enters

the date when the next service will be due.

Riders who cover long distances in a year might have to bring in their motorcycles for service before the next scheduled date. It is to allow for these cases that a maximum odometer reading is entered as well in the confirmation of service. Servicing has to be brought forward if this odometer reading is reached before the next scheduled date for the service.

The service-due indicator in the multifunction display reminds you about one month or 1000 km in advance when the time for a service is approaching, on the basis of the programmed values.

## Confirmation of maintenance work

BMW Pre-delivery  
Check  
Completed

on \_\_\_\_\_

\_\_\_\_\_  
Stamp, signature

BMW Running-in  
Check  
Completed

on \_\_\_\_\_

Odometer reading \_\_\_\_\_

Next service  
at the latest

on \_\_\_\_\_

or, if logged beforehand,

Odometer reading \_\_\_\_\_

\_\_\_\_\_  
Stamp, signature

BMW Service  
Completed

on \_\_\_\_\_

Odometer reading \_\_\_\_\_

Next service  
at the latest

on \_\_\_\_\_

or, if logged beforehand,

Odometer reading \_\_\_\_\_

\_\_\_\_\_  
Stamp, signature

BMW Service  
Completed

on \_\_\_\_\_

Odometer reading \_\_\_\_\_

Next service  
at the latest

on \_\_\_\_\_

or, if logged beforehand,

Odometer reading \_\_\_\_\_

\_\_\_\_\_  
Stamp, signature

BMW Service  
Completed

on \_\_\_\_\_

Odometer reading \_\_\_\_\_

Next service  
at the latest

on \_\_\_\_\_

or, if logged beforehand,

Odometer reading \_\_\_\_\_

\_\_\_\_\_  
Stamp, signature

BMW Service

Completed

on \_\_\_\_\_

Odometer reading \_\_\_\_\_

Next service

at the latest

on \_\_\_\_\_

or, if logged beforehand,

Odometer reading \_\_\_\_\_

\_\_\_\_\_  
Stamp, signature

BMW Service

Completed

on \_\_\_\_\_

Odometer reading \_\_\_\_\_

Next service

at the latest

on \_\_\_\_\_

or, if logged beforehand,

Odometer reading \_\_\_\_\_

\_\_\_\_\_  
Stamp, signature

BMW Service

Completed

on \_\_\_\_\_

Odometer reading \_\_\_\_\_

Next service

at the latest

on \_\_\_\_\_

or, if logged beforehand,

Odometer reading \_\_\_\_\_

\_\_\_\_\_  
Stamp, signature

BMW Service  
Completed

on \_\_\_\_\_

Odometer reading \_\_\_\_\_

Next service  
at the latest

on \_\_\_\_\_

or, if logged beforehand,

Odometer reading \_\_\_\_\_

\_\_\_\_\_  
Stamp, signature

BMW Service  
Completed

on \_\_\_\_\_

Odometer reading \_\_\_\_\_

Next service  
at the latest

on \_\_\_\_\_

or, if logged beforehand,

Odometer reading \_\_\_\_\_

\_\_\_\_\_  
Stamp, signature

BMW Service  
Completed

on \_\_\_\_\_

Odometer reading \_\_\_\_\_

Next service  
at the latest

on \_\_\_\_\_

or, if logged beforehand,

Odometer reading \_\_\_\_\_

\_\_\_\_\_  
Stamp, signature

BMW Service

Completed

on \_\_\_\_\_

Odometer reading \_\_\_\_\_

Next service

at the latest

on \_\_\_\_\_

or, if logged beforehand,

Odometer reading \_\_\_\_\_

\_\_\_\_\_  
Stamp, signature

BMW Service

Completed

on \_\_\_\_\_

Odometer reading \_\_\_\_\_

Next service

at the latest

on \_\_\_\_\_

or, if logged beforehand,

Odometer reading \_\_\_\_\_

\_\_\_\_\_  
Stamp, signature

BMW Service

Completed

on \_\_\_\_\_

Odometer reading \_\_\_\_\_

Next service

at the latest

on \_\_\_\_\_

or, if logged beforehand,

Odometer reading \_\_\_\_\_

\_\_\_\_\_  
Stamp, signature



## Confirmation of service

The table is intended as a record of maintenance and repair work, the installation of optional accessories and, if appropriate, special campaign (recall) work.

Item	Odometer reading	Date



- A
  - Abbreviations and symbols, 6
- ABS
  - Control, 14
  - Engineering details, 90
  - Operation, 59
  - Self-diagnosis, 80
  - Warnings, 31
- Accessories
  - General instructions, 98
- Air filter
  - Installation, 131
  - Position on the motorcycle, 13
  - Removal, 130
- Anti-theft alarm
  - Telltale light, 18
  - Warnings, 41
- ASC
  - Control, 14
  - Engineering details, 92
  - Operation, 60
  - Self-diagnosis, 80
  - Warnings, 33
- Auxiliary headlights
  - Control, 14
  - Operation, 55
- B
  - Battery
    - Charging battery when connected, 135
    - Charging battery when disconnected, 135
    - Installation, 136
    - Maintenance instructions, 134
    - Stowage, 17
    - Warning, charge current, 28
  - BMW Motorrad service, 160
  - Brake fluid
    - Reservoir, front, 13
    - Reservoir, rear, 13
  - Brake pads
    - Running in, 81
  - Brakes
    - Adjusting brake lever, 63
    - Checking brake-pad thickness, front brakes, 109
    - Checking brake-pad thickness, rear brakes, 110
    - Checking fluid level, front brakes, 111
    - Checking fluid level, rear brakes, 113
    - Checking operation, 108
    - Safety instructions, 83
    - Technical data, 152
    - Wear indicator, 111
- Bulbs
  - General instructions, 123
  - Overview, headlights, 19
  - Replacing auxiliary-headlight bulbs, 127
  - Replacing fuses for auxiliary headlights, 129
  - Replacing high-beam headlight bulb, 123
  - Replacing low-beam headlight bulb, 123
  - Replacing parking-light bulb, 125
  - Replacing turn indicator bulbs, 126
  - Technical data, 155
  - Warning, bulb failure, 28, 29

- C
- Case
  - Operation, 99
- Checklist, 78
- Clock, 22
  - Adjusting, 48
  - Control, 18
- Clutch
  - Adjusting clutch lever, 62
  - Checking fluid level, 114
  - Checking operation, 114
  - Fluid reservoir, 11
  - Technical data, 150
- Confirmation of maintenance work, 162
- Currency, 7
- D
- Damping
  - Adjuster, rear, 11
  - Adjusting, 67
- Dimensions, 156
- Display
  - See multifunction display, 18
- E
- Electrics
  - Technical data, 154
- Emergency off switch (kill switch), 16, 57
- Engine
  - Starting, 78
  - Technical data, 147
  - Temperature gauge, 22
  - Warning, engine electronics, 27
- Engine oil
  - Checking fill level, 107
  - Filler neck, 13
  - Fill-level indicator, 11
  - Technical data, 149
  - Topping up, 108
  - Warning, engine oil level, 31
  - Warning, engine oil pressure, 28
- Equipment, 7
- ESA
  - Control, 14
  - Engineering details, 95
  - Operation, 68
- F
- Frame
  - Technical data, 156
- Front-wheel stand
  - Installing, 121
- Fuel
  - Filler neck, 13
  - Fill-level indicator, 22
  - Refuelling, 85
  - Technical data, 148
  - Warning, fuel down to reserve, 27
- Fuses, 154
  - Replacing fuses for auxiliary headlights, 129
- G
- Gear indicator, 22
- General views
  - Headlight, 19
  - Instrument panel, 18
  - Left handlebar fitting, 14
  - Left side of motorcycle, 11
  - Multifunction display, 22
  - Right handlebar fitting, 16
  - Right side of motorcycle, 13

- Telltale lights, 22
- Underneath the seat, 17
- Grip heating
  - Control, 16
- H
- Handlebar fittings
  - General view, left side , 14
  - General view, right side, 16
- Handlebars
  - Adjusting, 65
- Hazard warning flashers
  - Control, 14, 16
  - Operation, 56
- Headlight
  - Beam throw, 71
  - Driving on right/driving on left, 71
  - Headlight beam-throw adjustment, 11
  - Overview, 19
- Headlight flasher, 14
- Helmet holder, 17, 73

- High-beam headlight
  - Control, 14
  - Switching on, 55
  - Telltale light, 22
- Horn, 14
- I
- Idle
  - Telltale light, 22
- Ignition
  - Switching off, 46
  - Switching on, 46
- Immobiliser, 47
  - Warning, 27
- Instrument cluster
  - Overview, 18
- J
- Jump starting, 133
- K
- Keys, 46
- L
- Laying up, 142

- Lights
  - Auxiliary headlights, 55
  - Headlight flasher, 55
  - Parking light, 55
  - Switching on high-beam headlight, 55
  - Switching on low-beam headlight, 55
  - Switching on the side lights, 55
- Low-beam headlight
  - Switching on, 55
- Luggage
  - Instructions for loading and securing objects, 76
- M
- Maintenance, 161
  - General instructions, 106
- Mirrors
  - Adjusting, 64
- Mobility services, 160
- Motorcycle
  - Laying up, 142
  - Restoring to use, 142

Multifunction display, 18  
  Overview, 22

## O

Odometer and tripmeters, 22  
  Control, 18  
  Operation, 49

Off-roading, 82

On-board computer  
  Ambient temperature, 51  
  Average consumption, 52  
  Average speed, 52  
  Control, 14  
  Oil level, 53  
  Operation, 51  
  Range, 53  
  Status indicators, 23  
  Warnings, 29

## P

Parking, 84

Parking light, 55

Power socket, 11  
  Notes on use, 98

Pre-ride check, 79

## R

Rear-wheel drive  
  Technical data, 151

Refuelling, 13, 85

Reserve volume  
  Warning, 27

Residual range, 50

Rev. counter, 18

Rider's Manual  
  Stowage, 17

Running gear  
  Technical data, 151

Running in, 81

## S

Safety instructions  
  for riding, 76

Seats  
  Adjusting seat height, 61  
  Lock, 11  
  Removing and installing, 72

Service, 160

Service-due indicator, 23

Shift lever  
  Adjusting, 64

## Side light

  Switching on, 55

Spark plugs  
  Technical data, 154

Speedometer, 18

Spring preload  
  Adjuster, front, 11  
  Adjuster, rear, 13  
  Adjusting, 65

Starting, 78  
  Control, 16

Status indicators  
  Standard status indicators, 22  
  Warnings, 24  
  With on-board computer, 23  
  With RDC, 24

Steering lock, 46

## T

Technical data  
  Brakes, 152  
  Bulbs, 155  
  Clutch, 150  
  Dimensions, 156  
  Electrics, 154

- Engine, 147
- Engine oil, 149
- Frame, 156
- Fuel, 148
- Rear-wheel drive, 151
- Running gear, 151
- Spark plugs, 154
- Standards, 7
- Transmission, 150
- Weights, 157
- Wheels and tyres, 153
- Telltale lights
  - Overview, 22
- Toolkit
  - Contents, 106
  - Stowage, 17
- Topcase
  - Operation, 101
- Torques, 145
- Transmission
  - Technical data, 150
- Transportation
  - Lashing, 86
- Troubleshooting chart, 144

- Turn indicators
  - Control, left, 14
  - Control, right, 16
  - Operation, 56
  - Telltale light, 22
- Type plate, 11
- Tyre pressure monitoring RDC
  - Adhesive label for rim, 116
  - Engineering details, 94
  - Operation, 54
  - Status indicators, 24
  - Warnings, 36
- Tyres
  - Checking inflation pressure, 71
  - Pressures, 153
  - Recommendation, 115
  - Running in, 82
  - Table of tyre pressures, 17
  - Technical data, 153
  - Top speed, 77

## V

- Vehicle identification number, 13

## W

- Warnings, 24
  - With ABS, 31
  - With anti-theft alarm, 41
  - With ASC, 33
  - With on-board computer, 29
  - With RDC, 36
- Warnings, overview, 26, 30, 32, 34, 38, 42
- Weights, 157
  - Payload table, 17
- Wheels
  - Change of size, 115
  - Checking spokes, 115
  - Installing front wheel, 118
  - Installing rear wheel, 120
  - Remove the front wheel, 116
  - Remove the rear wheel, 120
  - Technical data, 153
- Windscreen
  - Adjuster, 11
  - Adjusting, 62

Details described or illustrated in this booklet may differ from the motorcycle's actual specification as purchased, the accessories fitted or the national-market specification. No claims will be entertained as a result of such discrepancies.

Dimensions, weights, fuel consumption and performance data are quoted to the customary tolerances.

The right to modify designs, equipment and accessories is reserved.

Errors and omissions excepted.

© 2010 BMW Motorrad

Not to be reproduced either wholly or in part without written permission from BMW Motorrad, After Sales.

Printed in Germany.



The most important data for a filling-station stop can be found in the following chart:

<b>Fuel</b>	
Recommended fuel grade	Premium plus unleaded 98 ROZ/RON 91 AKI
alternative fuel grade	Premium unleaded (slight power- and consumption-related restrictions) 95 ROZ/RON 89 AKI
– with regular unleaded (RON 91) <sup>OE</sup>	Regular unleaded (power- and consumption-related restrictions) 91 ROZ/RON 87 AKI
Usable fuel capacity	approx. 33 l
Reserve fuel	approx. 4 l
<b>Tyre pressures</b>	
Tyre pressure, front	2.2 bar, one-up, tyre cold 2.5 bar, two-up and/or with luggage, tyre cold
Tyre pressure, rear	2.5 bar, one-up, tyre cold 2.9 bar, two-up and/or with luggage, tyre cold

**BMW recommends** 

Order No.: 01 41 8 520 431  
02.2010, 2nd edition

